

Operating Instruction Manual
CUT YOUR ENERGY BILLS & CARBON FOOTPRINT

**EVI DC Inverter
Heat Pump
(Built-in water pump)**

ECOLOGICAL SOLUTIONS



CONTROLLER COMPATIBLE WITH:
Products controllable via the dedicated
Smart Life – Smart Living and Tuya Smart apps.

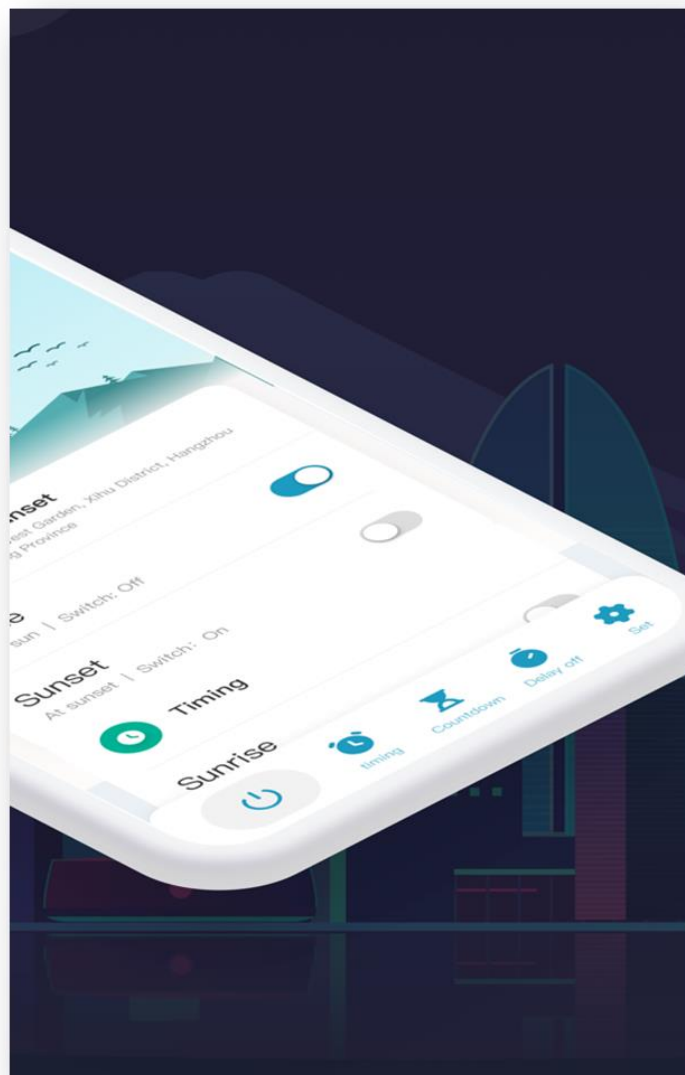



**IMPORTANT SAFETY INSTRUCTIONS
READ AND FOLLOW ALL INSTRUCTIONS
SAVE THESE INSTRUCTIONS**



IMPORTANT SAFETY PRECAUTIONS

Important Notice:

This guide provides installation and operation instructions for the EVI DC Inverter Air Source Heat Pump. Consult the seller with any questions regarding this equipment.

Attention Installer: This guide contains important information about the installation, operation and safe use of this product. This information should be given to the owner and/or operator of this equipment after installation or left on or near the heat pump.

Attention User: This manual contains important information that will help you in operating and maintaining this heat pump. Please retain it for future reference.

 **WARNING** - Before installing this product, read and follow all warning notices and instructions which are included. Failure to follow safety warnings and instructions can result in severe injury, death, or property damage.

Codes and Standards

The EVI DC Inverter Air Source Heat Pump must be installed in accordance with the local building and installation codes as per the utility or authority having jurisdiction. All local codes take precedence over national codes. In the absence of local codes, refer to the latest edition of the National Electric Code (NEC) in the local government Electric Code (CEC) for installation.

DANGER – Risk of electrical shock or electrocution.



The electrical supply to this product must be installed by a licensed or certified electrician in accordance with the National Electrical Code and all applicable local codes and ordinances. Improper installation will create an electrical hazard which could result in death or serious injury to heat pump users, installers, or others due to electrical shock, and may also cause damage to property. Read and follow the specific instructions inside this guide.

 **WARNING** - To reduce the risk of injury, do not permit children to use this product unless they are closely supervised at all times.

Consumer Information and Safety

The EVI DC Inverter Air Source Heat Pumps are designed and manufactured to provide years of safe and reliable service when installed, operated and maintained according to the information in this manual and the installation codes referred to in later sections. Throughout the manual, safety warnings and

cautions are identified by the “” symbol. Be sure to read and comply with all of the warnings and cautions.

Heat Pump Energy Saving Tips

If you do not plan to use hot water for a prolonged period, then you might choose to turn the heat pump off or decrease the temp. setting of the control several degrees to minimize energy consumption.

We offer the following recommendations to help conserve energy and minimize the cost of operating your heat pump without sacrificing comfort.

1. A maximum water temp. of 60°C is recommended.
2. It is recommended to turn off the heat pump when ambient air temp. is less than -30°C or if on vacation for longer than a week.
3. To save energy, it is recommended that the heat pump is operated during daytime when the ambient temp. is higher.
4. Try to install the heat pump at the ventilated places outdoor. Where possible, shelter the heat pump from prevailing winds, rain and snow. Always use a shelter when practical, which will reduce the possibility of frosting and icing.

General Installation Information

1. Installation and service must be performed by a qualified installer or service agent, and must conform to all national, state, and local codes and/or safety regulations.
2. This EVI DC Inverter Air Source Heat Pump is specifically designed for domestic hot water & house heating.

Product Overview

EVI DC Inverter Air Source heat pumps transfer heat from the ambient air to water, providing high-temp. hot water up to 70°C. The unique high-temp. heat pump is widely used for house warming. With innovative & advanced technology, the heat pump can operate very well at -20°C ambient temp. with high output temps up to 60°C, which ensures the compatibility with normal sized radiator based systems without supplementation. Compared with traditional oil/LPG boilers, EVI DC Inverter heat pump produces up to 50% less CO₂ whilst saves 80% running cost. Our heat pumps are not only highly efficient, but also easy and safe to operate.

General Features

1. Low running costs and high efficiency
 - A high coefficient of performance (COP) of up to 5 results in lower running costs compared with traditional ASHP technology.
 - No immersion heater supplement is required.
2. Reduced Capital Costs
 - Simple installation
3. High Comfort Levels
 - High storage temp. results in increased hot water availability.
4. No potential danger of any inflammable, gas poisoning, explosion, fire, electrical shock which are associated with other heating systems.
5. A digital controller is incorporated to maintain the desired water temp..
6. Long-life and corrosion resistant composite cabinet stands up to severe climates.
7. Panasonic compressor ensures outstanding performance, ultra energy efficiency, durability and quiet operation.
8. Self-diagnostic control panel monitors and troubleshoots heat pump operations to ensure safe and reliable operation.
9. Intelligent digital controller with friendly user interface and blue LED back light.
10. Separate isolated electrical compartment prevents internal corrosion and extends heat pump life.
11. The heat pump can operate down to ambient air temp. of -20°C.



The following general information describes how to install the EVI DC Inverter air source heat pump.

Note: Before installing this product, read and follow all warning notices and instructions. Only a qualified service person should install the heat pump.

Materials Needed for Installation

The following items are needed and are to be supplied by the installer for all heat pump installations:

1. Plumbing fittings.
2. Level surface for proper drainage.
3. Ensure that a suitable electrical supply line is provided. See the rating plate on the heat pump for electrical specifications. Please take a note of the specified current rating. No junction box is needed at the heat pump; Connections are made inside of the heat pump electrical compartment. Conduit may be attached directly to the heat pump jacket.
4. It is advised to use PVC conduit for the electrical supply line.
5. Use a booster pump for pumping water in case of low water pressure.
6. A filter on the water inlet is needed.
7. The plumbing should be insulated to reduce its heat loss.

Note: We recommend installing shut-off valves on the inlet and outlet water connections for ease of serviceability.

Technical data

ALPS EXCLUSIVE - URBAN V2 LINE					
BOM code	CP-RW0300114	CP-RW0400086	CP-RW0500125	CP-RW0500126	CP-RW0600061
Model	AE-08301-MO-V 2	AE-11403-MO-V 2	AE-14803-MO-V 2	AE-14803-MO-V 2	AE-22003-MO-V 2
Heating Condition - Ambient Temp. (DB/WB) : 7/6°C, Water Temp. (In/Out) : 30/35°C					
Heating Capacity Range (kW)	3.3~8.3	4.5~11.4	5.9~14.8	5.9~14.8	8.8~22.0
Heating Power Input Range(kW)	0.64~2.18	0.85~2.95	1.13~3.83	1.13~3.83	1.68~5.77
COP Range	3.81~5.17	3.86~5.29	3.86~5.22	3.86~5.22	3.81~5.24
DHW Condition-Ambient Temp. (DB/WB) : 7/6°C, Water Temp. (In/Out) : 15/55°C					
Heating Capacity Range (kW)	3.7~7.4	5.2~10.2	6.6~13.2	6.6~13.2	7.8~17.6
Heating Power Input Range(kW)	0.79~2.10	1.10~2.87	1.41~3.73	1.41~3.73	1.67~5.01
COP Range	3.52~4.69	3.55~4.71	3.54~4.67	3.54~4.67	3.51~4.66
Cooling Condition - Ambient Temp. (DB/WB) :35/24°C, Water Temp. (In/Out) : 12/7°C					
Cooling Capacity Range (kW)	2.4~5.8	3.3~8.2	4.3~10.8	4.3~10.8	6.2~15.3
Cooling Power Input Range(kW)	0.79~2.19	1.08~3.07	1.39~3.99	1.39~3.99	1.99~5.60
EER Range	2.65~3.04	2.67~3.06	2.71~3.10	2.71~3.10	2.73~3.12
ErP Level (35°C)	A+++	A+++	A+++	A+++	A+++
Refrigerant	R290/0.8kg	R290/0.95kg	R290/1.15kg	R290/1.15kg	R290/1.4kg
Power supply	230V/1Ph/50Hz/60Hz			380V/3Ph/50-60Hz	
Diameter of pipe (mm)	DN25	DN25	DN25	DN25	DN25
Max water head(m)	9	9	9	9	12
Noise dB(A)	≤47	≤50	≤52	≤52	≤53
Net Weight (kg)	112	120	138	138	170
Net Dimension (L/W/H) mm	1080×460×820	1080×460×960	1080×480×1060	1080×480×1060	1080×480×1372
Operation Ambient Temp.	-25~43°C				
Operating water temperature (°C)	20~65°C (DHW)				
Operating water temperature (°C)	20~70°C (Heating)				
Operating water temperature (°C)	7~35°C (Cooling)				

Note: The above design and specifications are subject to change without prior notice for product improvement.

Detailed specifications of the units please refer to nameplate on the units.

Correct installation is required to ensure safe operation. The requirements for heat pumps include the following:

1. Dimensions for critical connections.
2. Field assembly (if required).
3. Appropriate site location and clearances.
4. Proper electrical wiring.
5. Adequate water flow.

This manual provides the information needed to meet these requirements. Review all application and installation procedures completely before continuing the installation.

Dimension:

AE-08301-MO-V2

Unit: mm

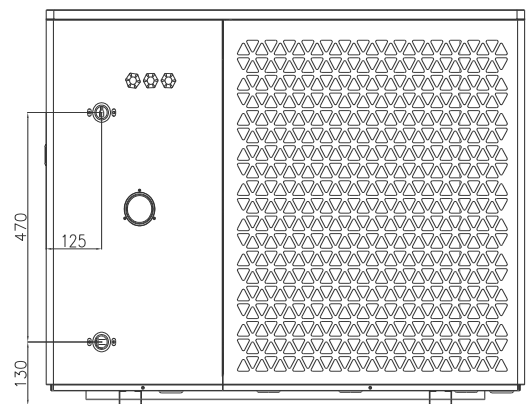
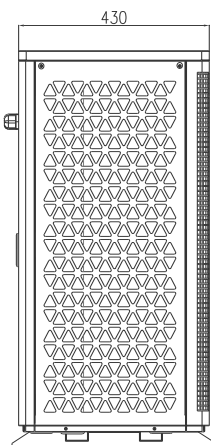
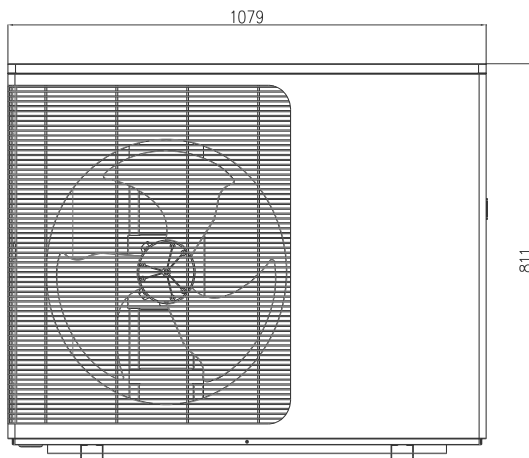
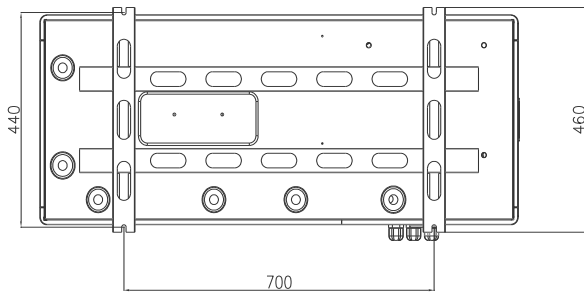

AE-11403-MO-V2

Unit: mm

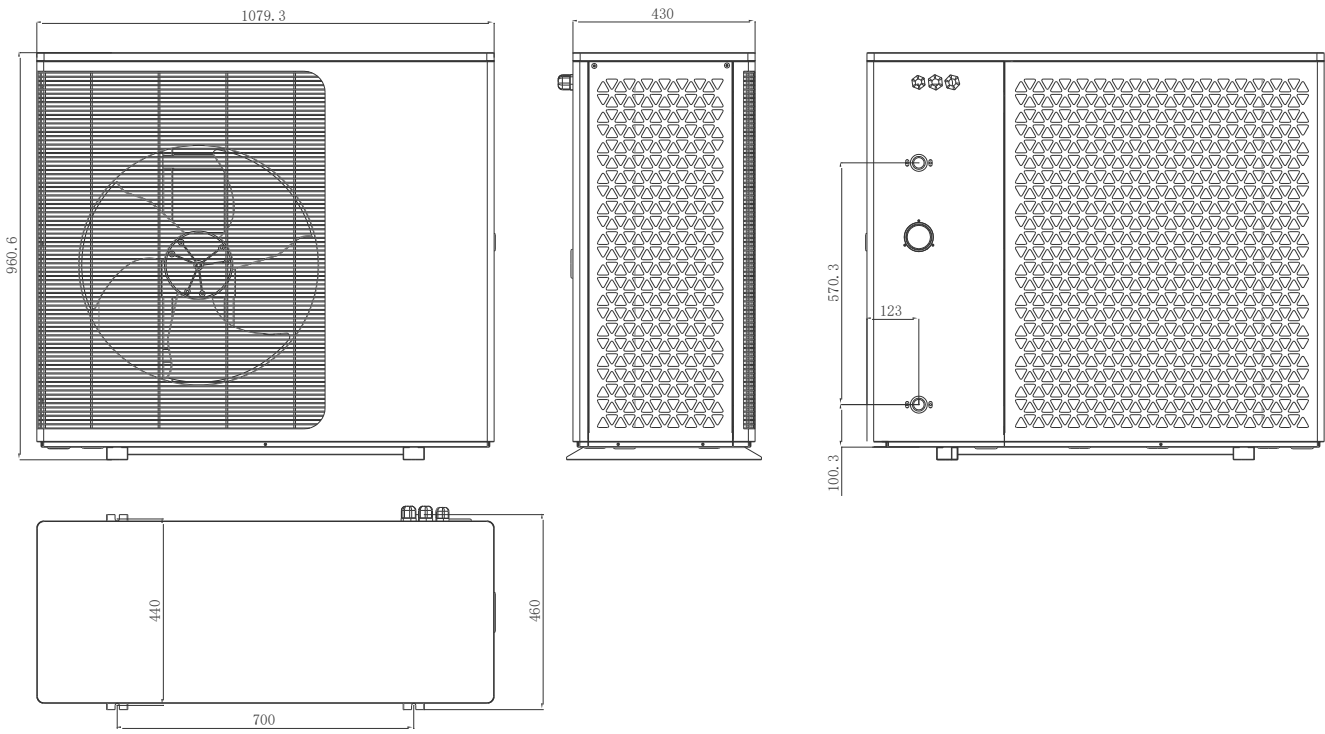

AE-14803-MO-V2

Unit: mm

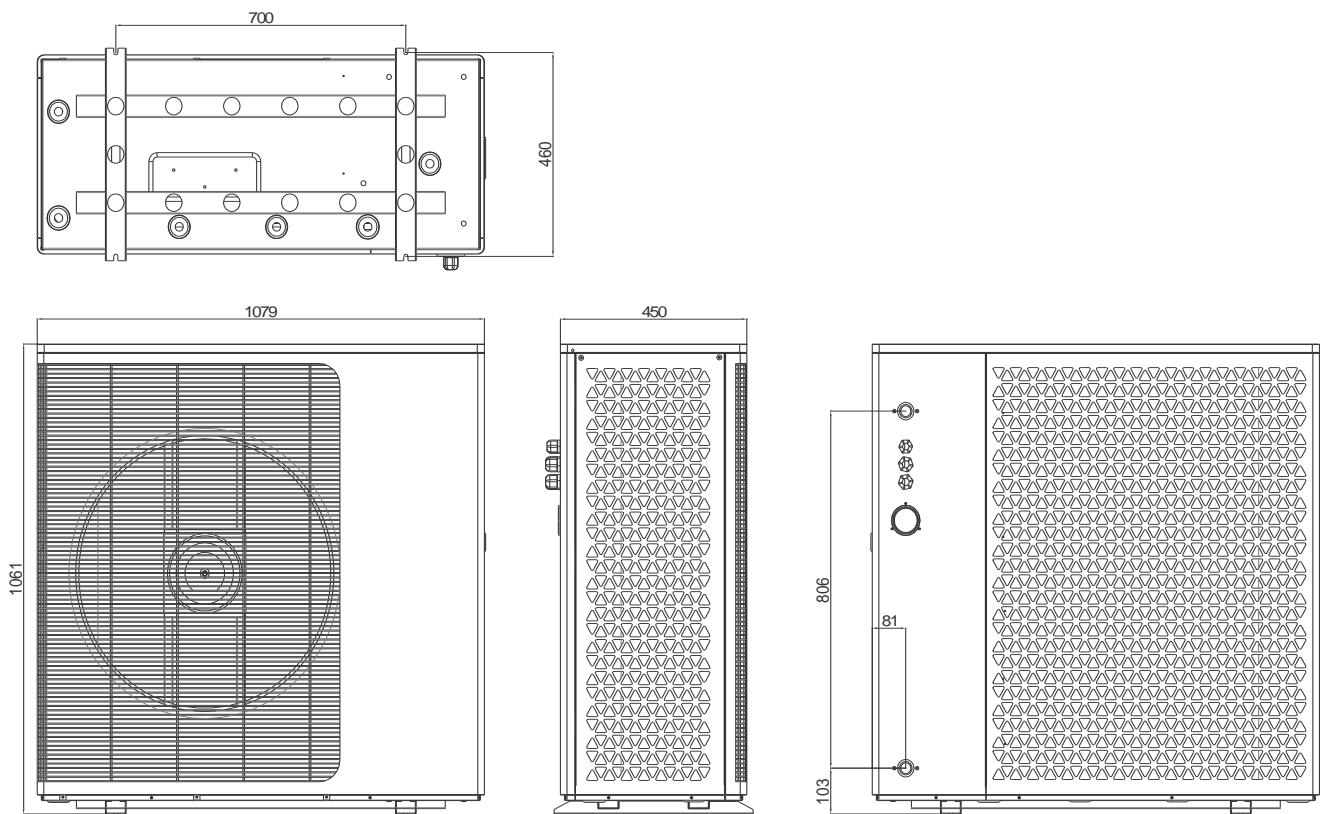

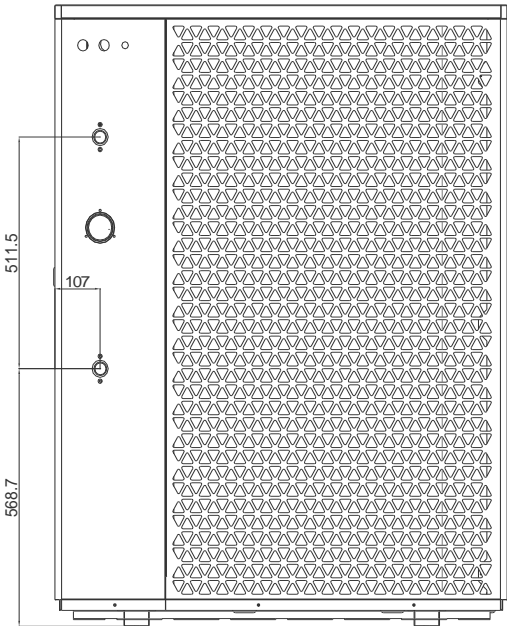
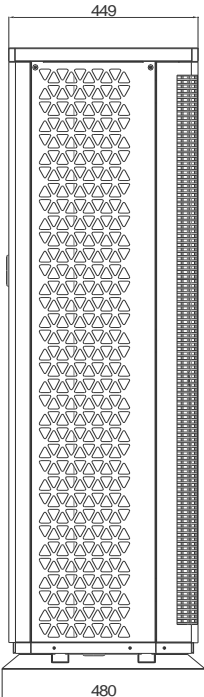
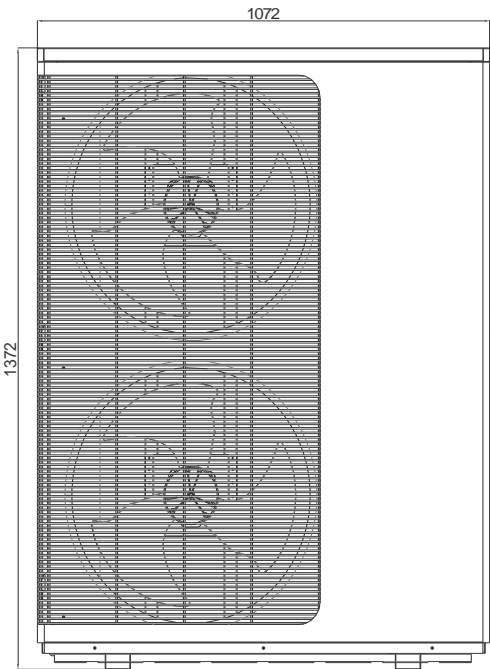
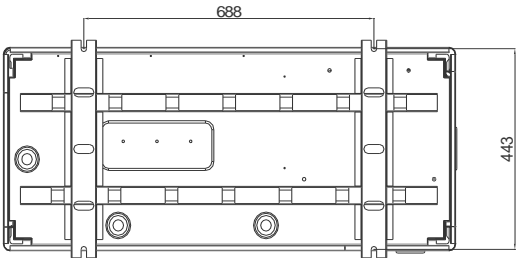

Exploded view

AE-08301-MO-V2

AE-11403-MO-V2

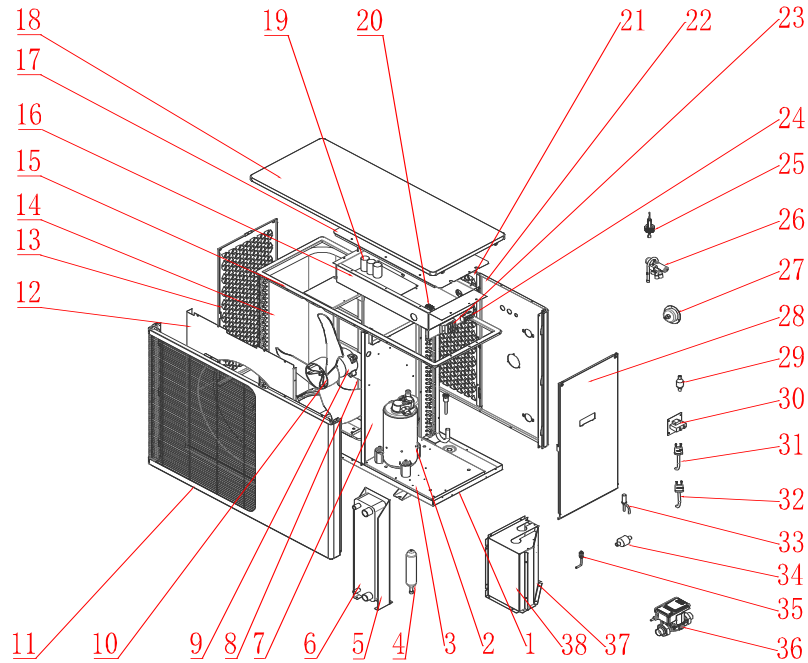

NO	Spare parts	NO	Spare parts
1	chassis	21	back net
2	compressor	22	rear side panel
3	damping plate	23	terminal block
4	liquid storage tank	24	terminal block
5	plate replacement support	25	water flow switch
6	plate heat exchanger	26	4-way valve
7	center spacer	27	pressure gauge
8	motor bracket	28	right side panel
9	motor	29	drying filter
10	fan blade	30	reactance
11	front panel	31	high voltage switch
12	Air guide panel	32	low voltage switch
13	left net	33	electronic expansion valve
14	fin heat exchanger	34	filter
15	top frame	35	needle valve
16	electric box	36	water pump
17	electric box cover	37	compressor hood 1
18	top panel	38	compressor hood 2
19	driver board		
20	transfer terminal block		

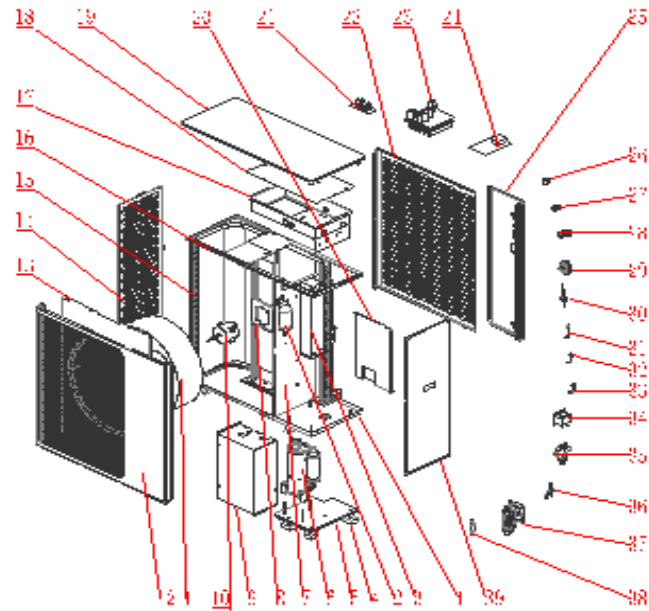

NO	Spares parts	NO	Spares parts
1	chassis	21	filter board
2	liquid storage tank	22	back net
3	plate heat exchanger	23	driver board
4	rubber pad	24	control board
5	damping plate	25	rear side panel
6	compressor	26	transfer terminal block
7	center spacer	27	transfer terminal block
8	motor bracket	28	transfer terminal block
9	dlimp	29	pressure gauge
10	motor	30	water flow switch
11	fan blade	31	needle valve
12	front panel	32	high voltage switch
13	Air guide panel	33	low voltage switch
14	left net	34	reactor
15	fin heat exchanger	35	4-way valve
16	top frame	36	electronic expansion valve
17	electric box	37	water pump
18	electric box cover	38	check valve
19	top panel	39	right side panel
20	dlimp		

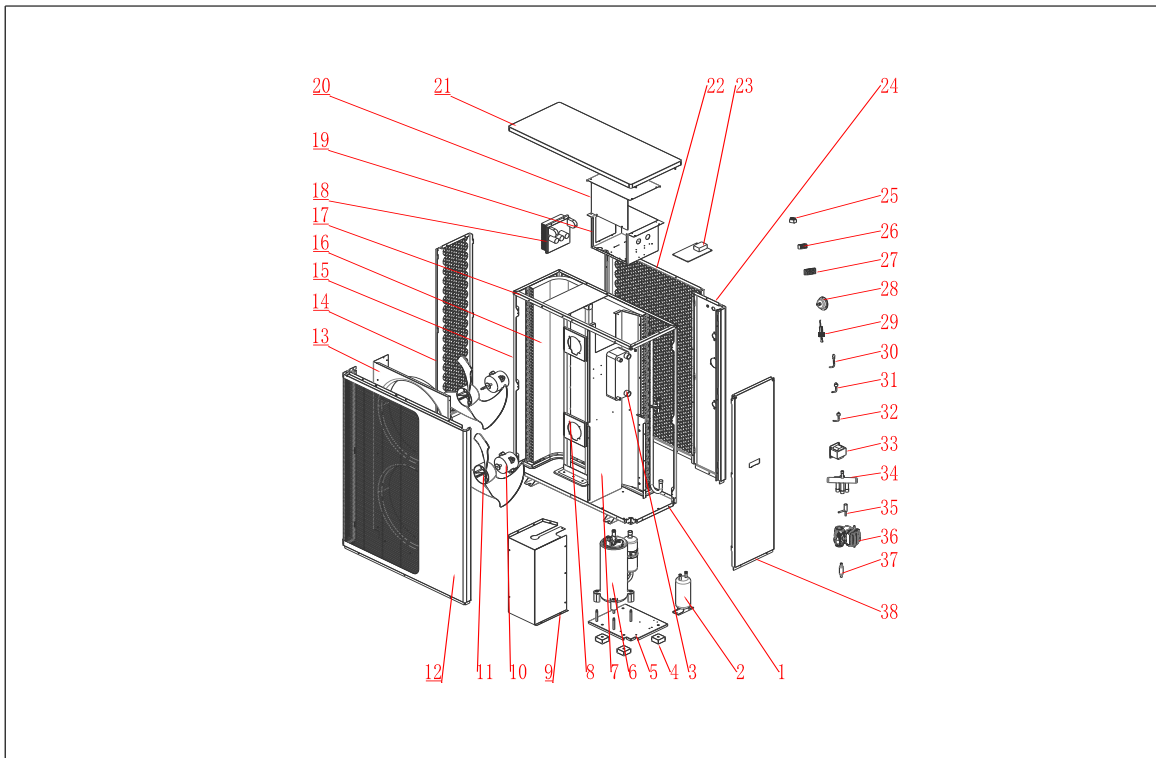

NO	Spare parts	NO	Spare parts
1	chassis	21	top panel
2	liquid storage tank	22	back net
3	plate heat exchanger	23	control board
4	rubber pad	24	rear side panel
5	damping plate	25	transfer terminal block
6	compressor	26	transfer terminal block
7	center spacer	27	transfer terminal block
8	motor bracket	28	pressure gauge
9	dlimp	29	water flow switch
10	motor	30	needle valve
11	fan blade	31	high voltage switch
12	front panel	32	low voltage switch
13	Air guide panel	33	reactor
14	left net	34	4-way valve
15	post	35	electronic expansion valve
16	fin heat exchanger	36	water pump
17	top frame	37	check valve
18	driver board	38	right side panel
19	electric box		
20	electric box cover		

Installation Location



CAUTION!

1. DO NOT install the heat pump near to hazardous materials and places.
2. DO NOT install the heat pump under deep sloping roofs without gutters which will allow rain water, mixed with debris, to be forced through the unit.
3. Place the heat pump on a flat slightly pitched surface, such as concrete or fabricated slab. This will allow proper drainage of condensation and rain water from the base of the unit. If possible, the slab should be placed at the same level or slightly higher than the filter system/equipment.

Installation Details

All criteria given in the following sections reflect minimum clearances. However, each installation must also be evaluated, taking into account the prevailing local conditions such as proximity and height of walls, and proximity to public access areas. The heat pump must be placed to provide clearances on all sides for maintenance and inspection.

1. The heat pump installation area must have good ventilation and the air inlet/outlet must not be hindered.
2. The installation area must have good drainage and be built on a solid foundation.
3. Do not install the unit in areas accumulated with pollutions like aggressive gas (chlorine or acidic), dust, sand and leaves etc.
4. For easier and better maintenance and troubleshooting, no obstacles around the unit should be closer than 1m. And no obstructions within 2m, vertically, from the unit for air ventilation.

(See Figure 1)

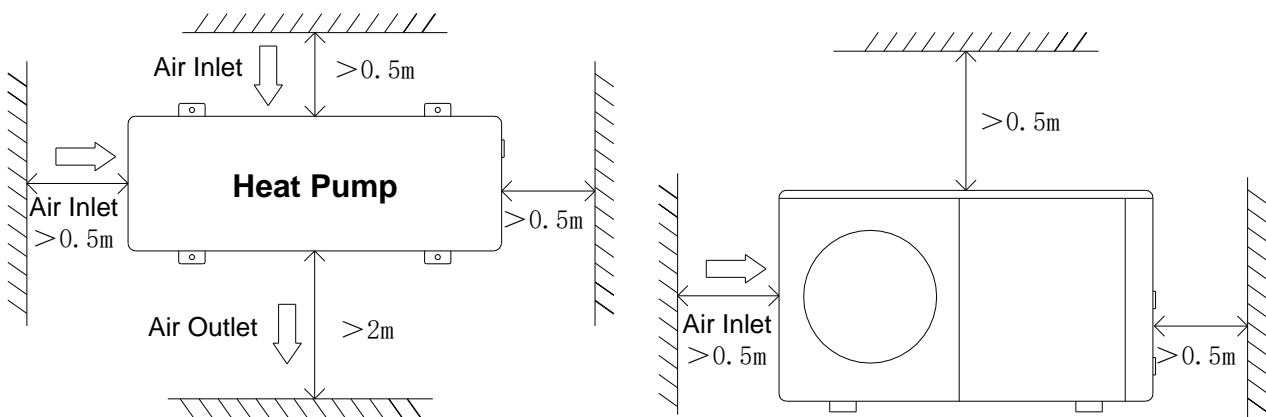

Figure 1

5. The heat pump must be installed with shockproof bushes to prevent vibration and/or imbalance.
6. Even though the controller is waterproof, care should be taken to avoid direct sunlight and high temp.. In addition, the heat pump should be placed to ensure quality viewing of the controller.
7. The plumbing pipes must be installed with proper support to prevent possible damage due to vibration. Running water pressure should be kept over 196kpa. Otherwise, booster pump should be installed.
8. The acceptable operating voltage range should be within $\pm 10\%$ of the rated voltage.
 - The heat pump unit must be grounded /earthed for safety purposes.

Drainage and Condensation

Condensation will occur from the evaporator when the unit is running and drain at a steady rate, depending upon ambient air temp. and humidity. The more humid the ambient conditions, the more condensation will occur. The bottom of the unit acts as a tray to catch rainwater and condensation. Keep the drain holes, located on the bottom pan of the unit base, clear from debris at all times.

Suggested Installation Methods

DC Inverter Heat Pump can provide heating/cooling and domestic hot water. Floor heating loops and Radiator are used for space heating and fan coil units are used for space cooling. Domestic hot water is supplied from the domestic hot water tank connected to the heat pump.

DC Inverter Heat Pump with a main circulation pump built inside. When install the unit, installers should connect the heat pump with other parts including the buffer tank (for space heating/cooling), storage water tank (for domestic hot water) . External fittings are also needed including a safety valve, a water charge valve, Three-way valve. Temperature sensor should be added in the storage water tank. An additional electric heater can be installed in the DHW tank or the buffer tank which can get the control signal from the heat pump.

- 1) System installation diagram to see Figure 2 Figure 3.
- 2) 3-way valve: For domestic hot water mode, 3-way valve powers on. For underfloor heating or cooling, 3-way valve powers off.
- 3) When both heating(or cooling) and domestic hot water don't reach the setting temp., hot water is priority.
- 4) The hot water tank with coil for domestic hot water should be specially customized.
- 5) The heat exchange capacity of the coil should be \geq the rated heating capacity of the heat pump.
- 6) The unit is delivered ready for operation and is filled with R290 refrigerant.

Schematic diagram cycle installation

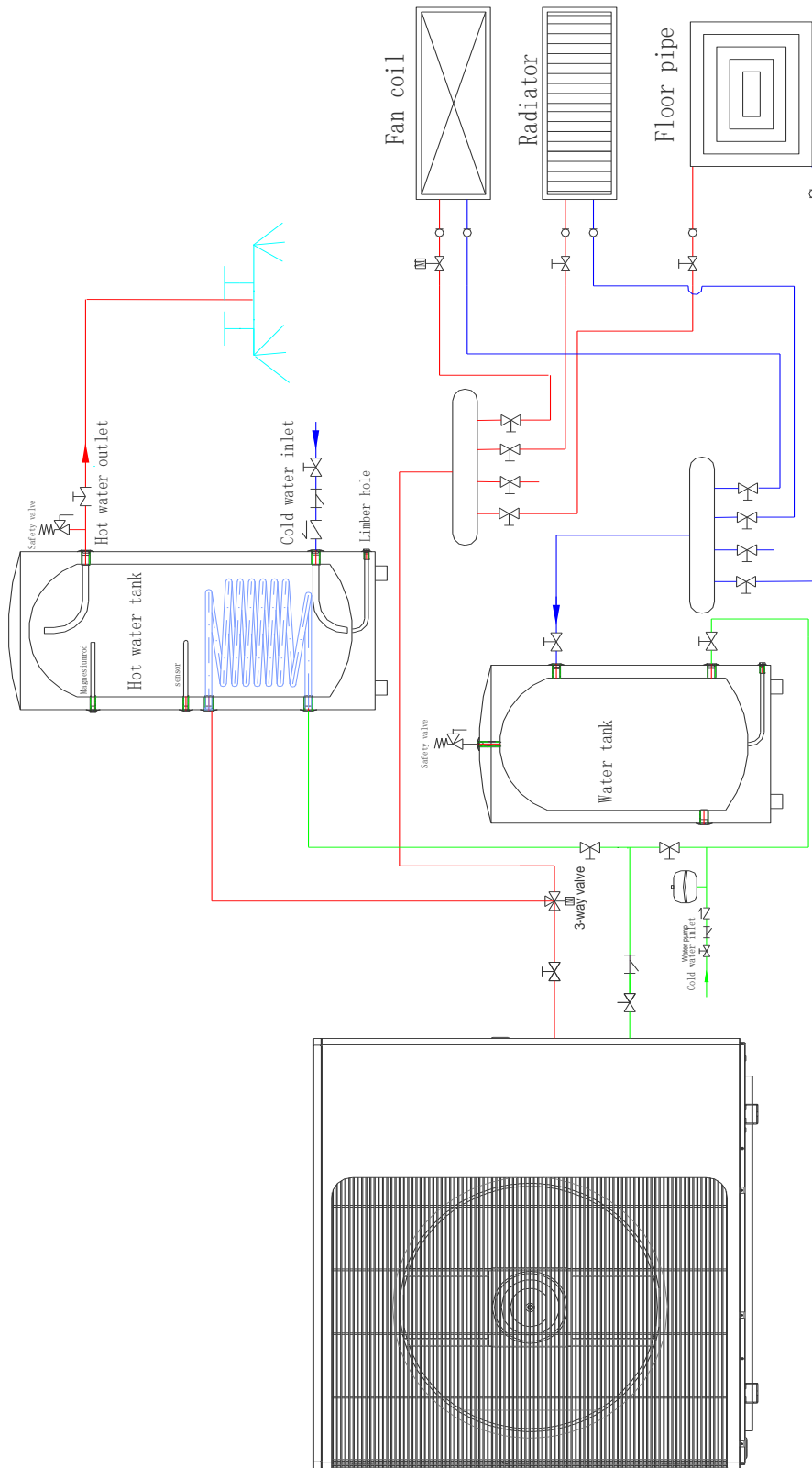

Water Connections

Water Connections at the Heat Pump

Quick Connect fittings are recommended to be installed on the water inlet and outlet connections. It is recommended to use stainless steel or PPR pipes for the heat pump plumbing. The water inlet and outlet connection to the heat pump accepts stainless steel or PPR pipe fittings.



CAUTION — Make sure that flow requirements and tap water turnover rates can be maintained with the installation of additional heat pumps and plumbing restrictions.

Plumbing Installation Requirements

1. When water pressure exceeds 490Kpa, please use reducing valve to reduce the water pressure below 294Kpa.
2. Each part connected to unit needs to be connected with method of loose joint and installed with intermediate valve.
3. Ensure that all plumbing has been properly completed and then proceed to do a water leakage and pressure test.
4. All the pipelines and pipe fittings must be insulated to prevent heat loss.
5. Install a drain valve at the lowest point of the system to enable the system to be drained during freezing conditions (winterizing).
6. Install a check valve on the water outlet connection in order to prevent back siphoning when water pump stops.
7. In order to reduce the back pressure, the pipes should be installed horizontally
8. And minimize the elbows (90 degrees connections). If a higher flow rate is required, install a bypass valve

Electrical Connections



WARNING —Risk of electrical shock or electrocution.



Ensure that all high voltage circuits are disconnected before commencing heat pump installation. Contact with these circuits could result in death or serious injury to users, installers or others, due to electrical shock and may also cause damage to property.



CAUTION — Label all wires prior to disconnection when servicing the heat pump. Wiring errors can cause improper and dangerous operation. Check and ensure proper operation after servicing.

Power Supply

1. If the supply voltage is too low or too high, it can cause damage and/or result in unstable operation of the heat pump unit, due to high inrush currents on start up.
2. The minimum starting voltage should be above 90% of rated voltage. The acceptable operating voltage range should be within $\pm 10\%$ of the rated voltage.
3. Ensure the cable specifications meet the correct requirements for the specific installation. The distance between the installation site and mains power supply will affect the cable thickness. Follow the local electrical standards to select the cables, circuit breakers and isolator breakers.

Grounding and Over Current Protection

In order to prevent electrical shock in case of leakage from unit, install the heat pump according to local electrical standard.

1. Do not interrupt the voltage supply to the heat pump frequently as this may result a shorter life expectancy of the heat pump.
2. When installing over current protection, ensure that the correct current rating is met for this specific installation.
3. If an additional auxiliary heater is need to be controlled by the heat pump controller, the relay (or power) of the aux-heater must be connected to the relevant output of the controller.

Electrical Wiring Diagram

1. Single phase system (AE-08301-M0-V2/AE-11403-M0-V2)

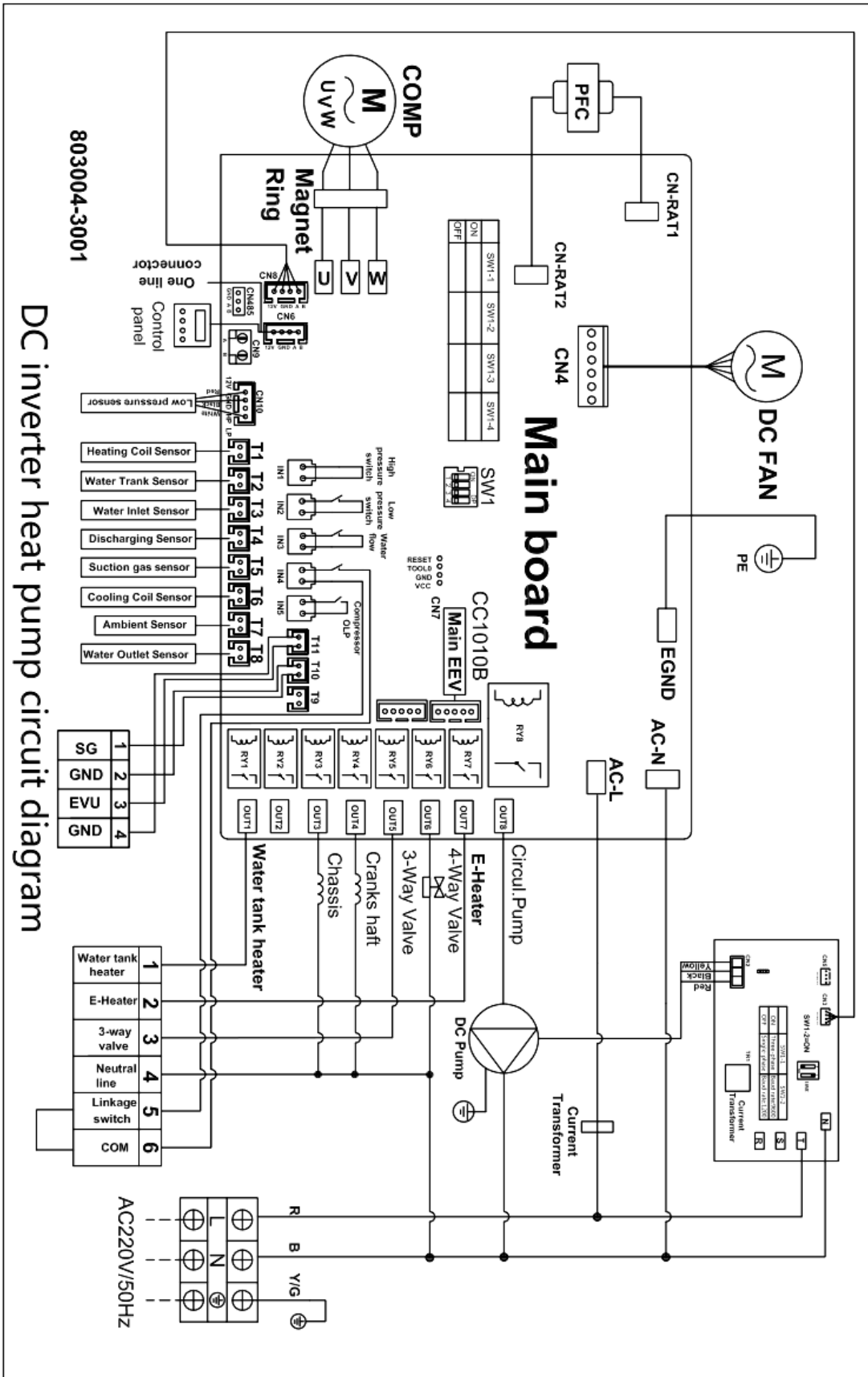

2. Single phase system (AE-14801-M0-V2)

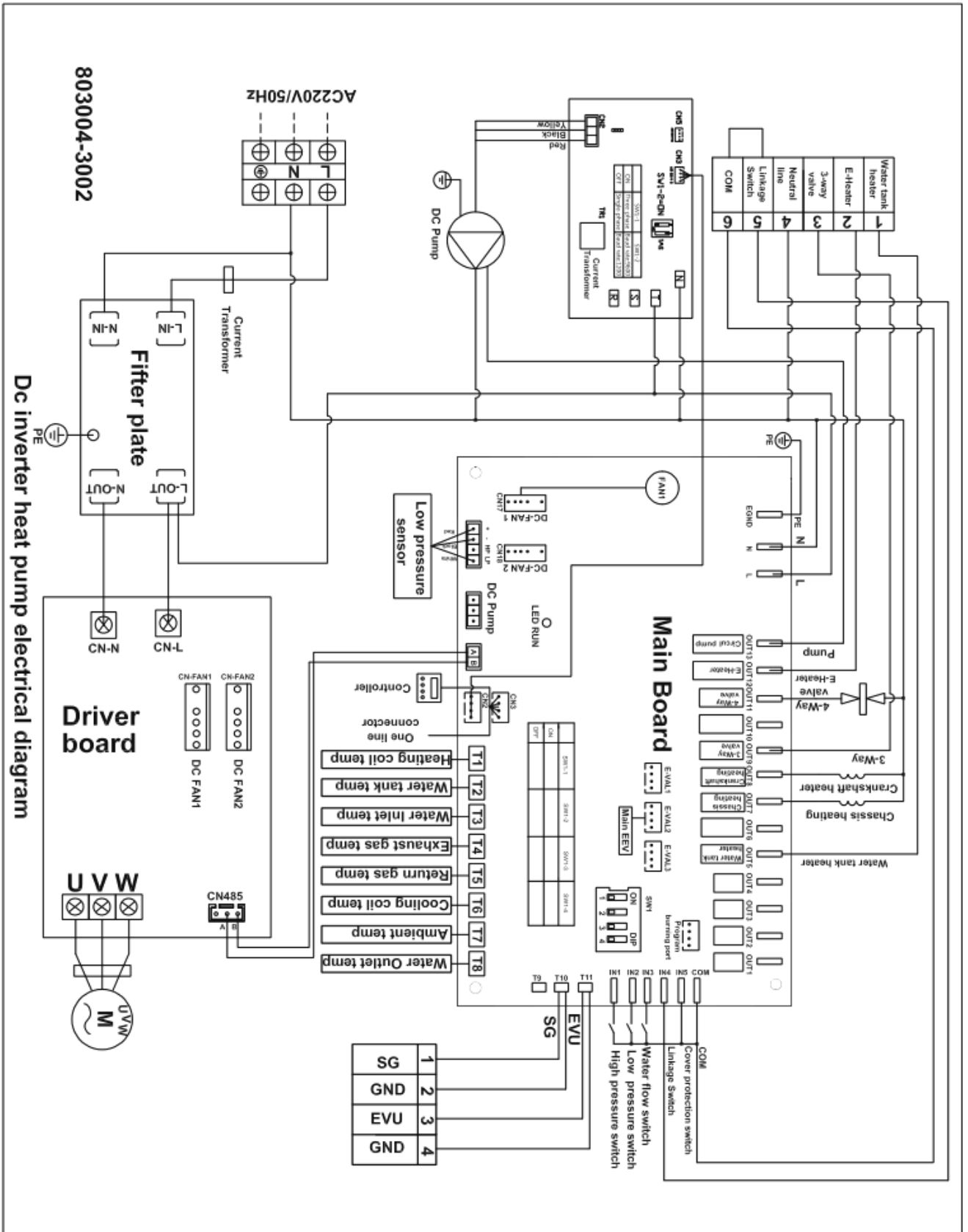



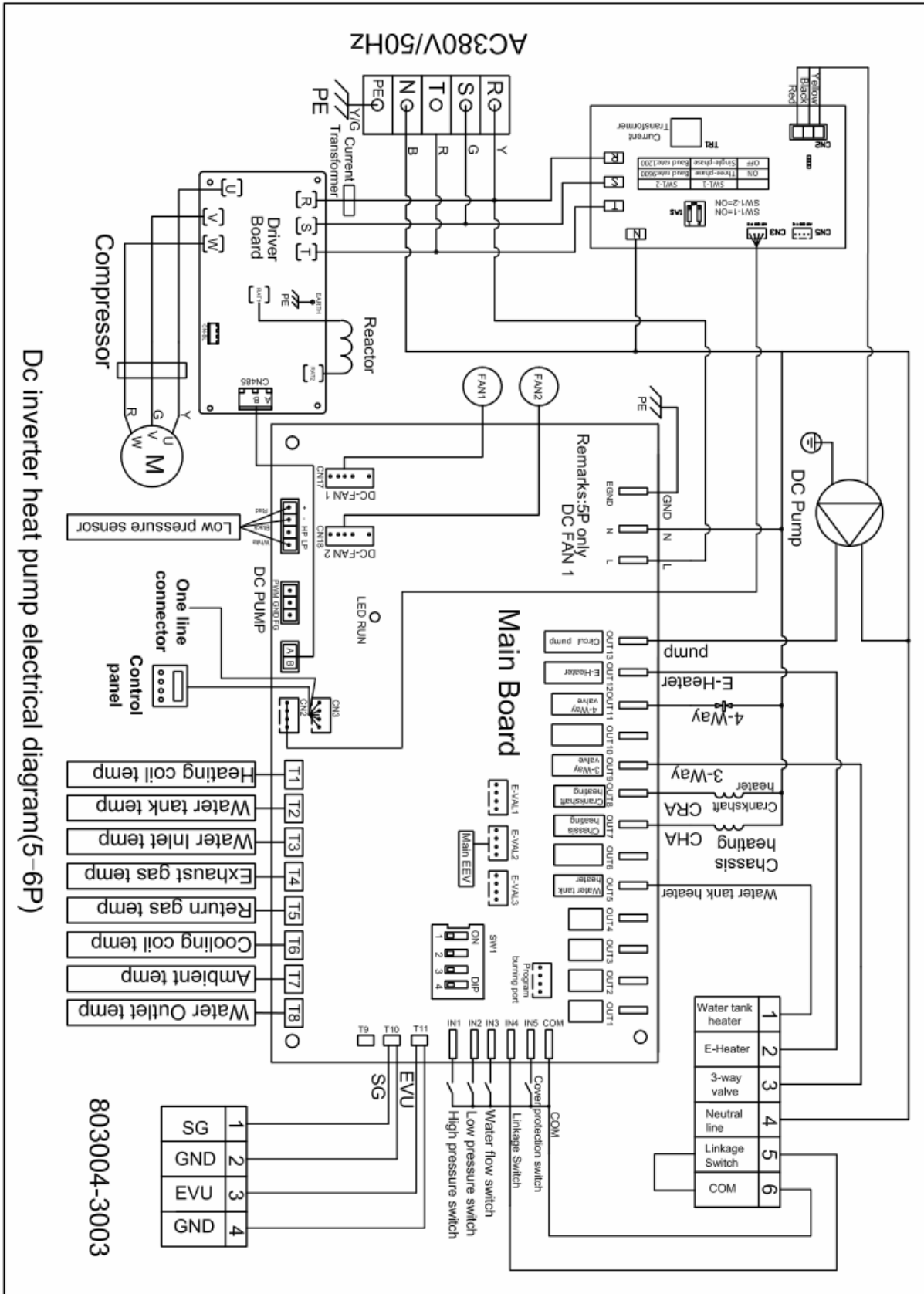











3. Three phase system (AE-14803-MO-V2/AE-22003-MO-V2)













Controller Panel



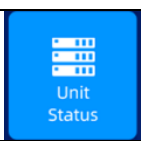
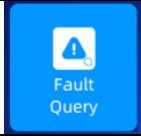

1. Display Icon

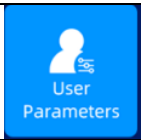
Mode	Meaning
	Heating mode
	Hot water mode
	Cooling mode
	Heating and Hot water Mode (Hot water function as priority)
	Cooling and Hot water Mode (Hot water function as priority)
	Smart mode
	Power mode
	Silent mode
	Vacation mode
	Compressor working
	Water pump working
	Fan motor working
	Electric heating working
	Defrosting
	Anti-freezing

2. Definition of Buttons

Button	Description	Function
	On/off	Turn on or turn off the heat pump.
	Mode	Switch the operating mode of the heat pump.
	Timer	Set timer switch and working weekdays.
	Setting	Query running parameters, check and set system parameters, error code records, Wifi connection, etc.
	Temperature setting 1	Temperature setting for only hot water, only heating and only cooling mode(the interface displays the inlet water temperature and outlet water temperature).
	Temperature setting 2	In hot water+heating or hot water+cooling mode, the left side is temperature setting for heating and cooling, and the right side is temperature setting for hot water (the main interface temperature display shows on the left side is inlet water temperature, and on the right side is water tank temperature).
	Status	Check the running parameters of the heat pump.
	Faulty	Record the most recent error codes.
	WiFi	WiFi setting.
	User parameters	Check and set the user parameters of the heat pump.
	Factory parameters	Check and set the factory parameters(Do not advise to amend the factory parameters).
	Run the curve	Check the inlet water and outlet water operation curves and operation power curves.

 System Parameters	System parameters	Check the version information of the system motherboard and the remote control program.
 Language	Language	Language selection.

3. Wire Controller Operation

START / STOP THE HEAT PUMP

©In the main interface, press ON/OFF button for 1 second and the “Startup confirmation” pop-up window pops up. After the startup is confirmed, the mode symbol is displayed in the startup status, but not in the shutdown status.

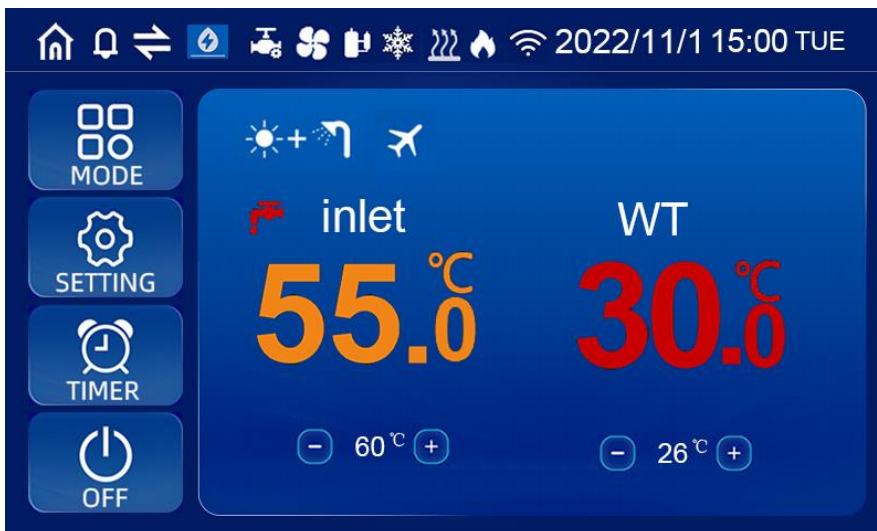

SET TARGET WATER TEMPERATURE

In single mode (only cooling, only heating, only hot water mode), click "+" and "-" on the main interface to adjust the required temperature; in dual mode (heating+hot water, cooling+hot water mode), click "+" and "-" on the left side of the main interface to adjust the required heating and cooling temperature; click "+" and "-" on the right side to adjust the required hot water temperature.

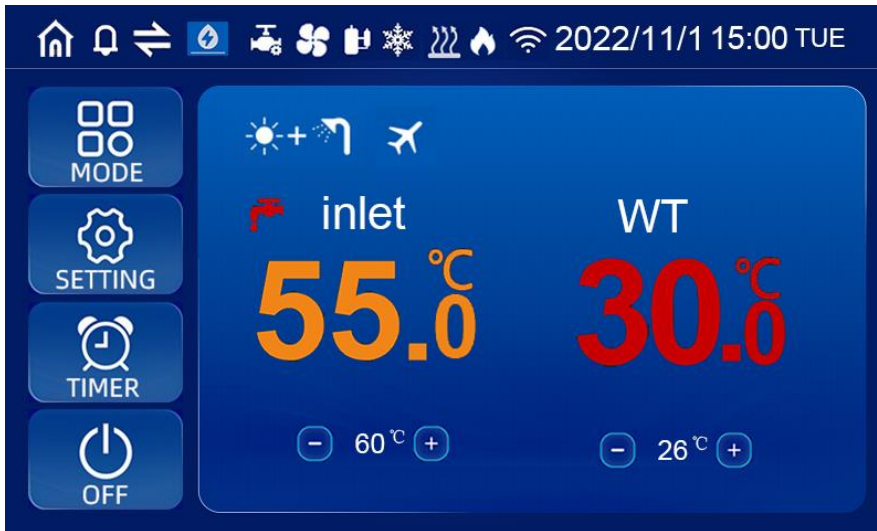

RUNNING MODE SETTING/OPERATING MODE SELECTION:

In the main interface, press the "MODE" key for 1 second to enter the operation mode, frequency mode and holiday mode selection interface, and select the required operation mode (parameter setting model) and frequency mode of the unit:

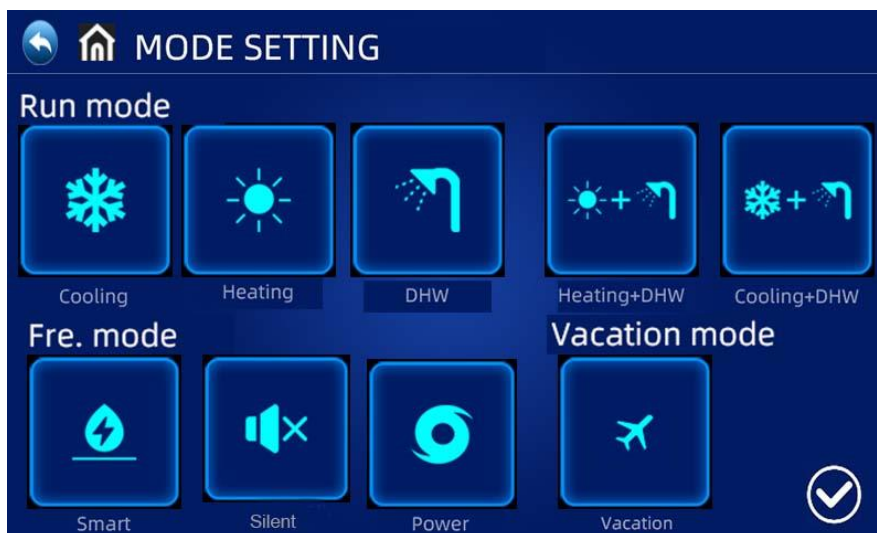

© Click "MODE" on the Setting interface to enter Operating mode selection interface.

⦿ Operating mode description: In the normal mode, Heat pump has Smart, Powerful,& Silent Operating states to choose.

⦿ Vacation mode description: When this mode is enabled, The heat pump runs in heating mode only,with a Target temperature of vacation Set.

CLOCK SETTING

⦿ In the main interface, press to enter clock setting interface as below.

⦿ Press the date (Year/Month/Day column) or hour (Hour:Minute column), the keyboard will occur to input the value. Press the weekday (Weekday column) to switch from Mon. to Sun.

⦿ Press CONFIRM button to save and exit, or press CANCEL button to exit without saving.

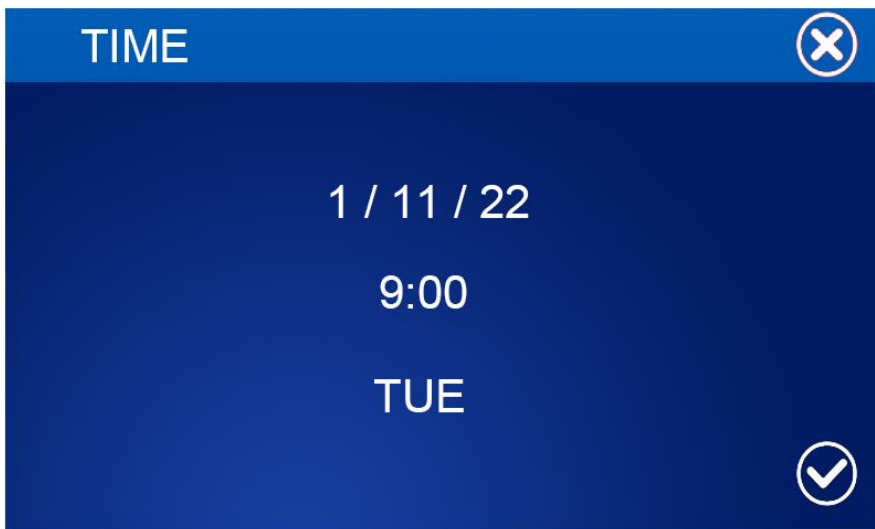

TIMER SETTING

- ⦿ In the main interface, press TIMER button to enter timing setting interface.
- ⦿ In the WEEK column, users can select which weekdays to perform timer switch. When the weekday button (From MON. to SUN.) turns highlight white, the timer will perform on that day. When the weekday button turns gray, the timer will not perform on that day.
- ⦿ In the TIMER column, users can set 4 pairs of timer at maximum.
- ⦿ The timer is invalid when the turn on time equals the turn off time in the same timer.



SILENT TIME



- ⦿ Click  in the “SET TIME” Interface to enter Timing silent interface, The unit will runs as Silent Mode during the scheduled mute time.

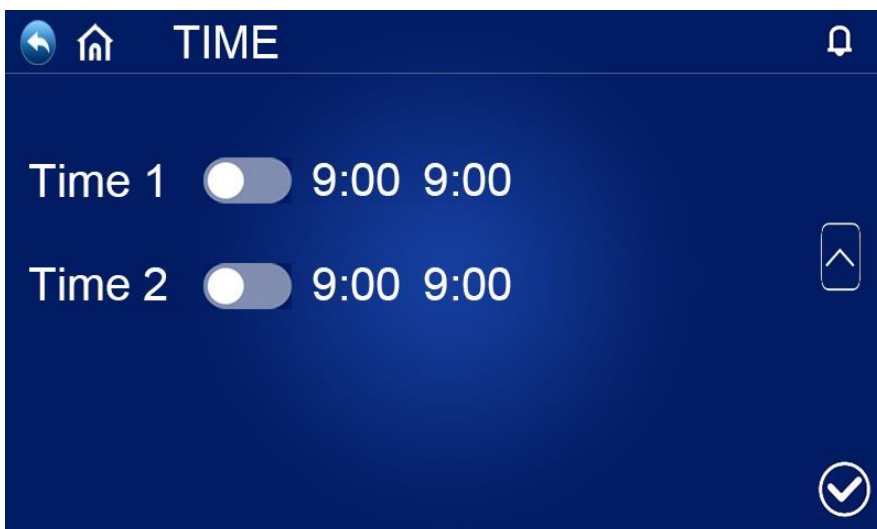

OPERATION PARAMETER QUERY

Press the "SETTING" key in the main interface to enter the setting interface. Then press "UNIT STATUS" to enter the unit list interface, select the corresponding unit to enter the "Parameter Query", and check the operation status of the heat pump. The status table is as follows:

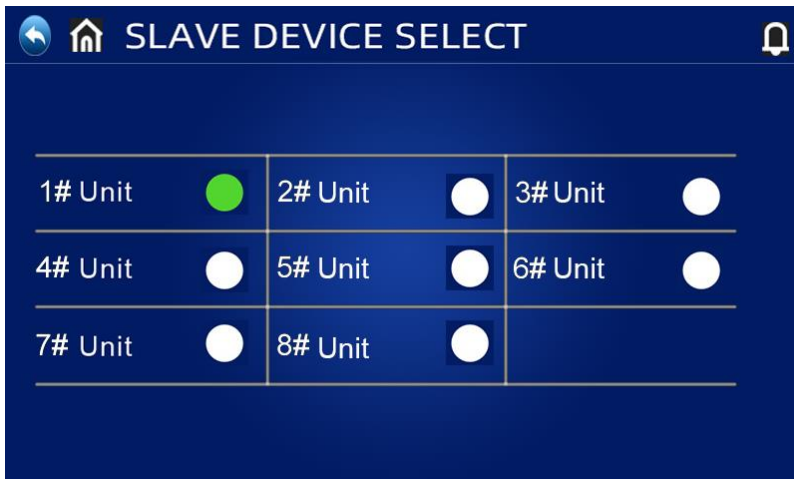

The screenshot shows a dark blue interface titled "SLAVE DEVICE SELECT". It contains a table with 8 units, each with a status indicator (a colored circle). Unit 1 is green, while units 2 through 8 are white.

1# Unit	<input checked="" type="radio"/>	2# Unit	<input type="radio"/>	3# Unit	<input type="radio"/>
4# Unit	<input type="radio"/>	5# Unit	<input type="radio"/>	6# Unit	<input type="radio"/>
7# Unit	<input type="radio"/>	8# Unit	<input type="radio"/>		

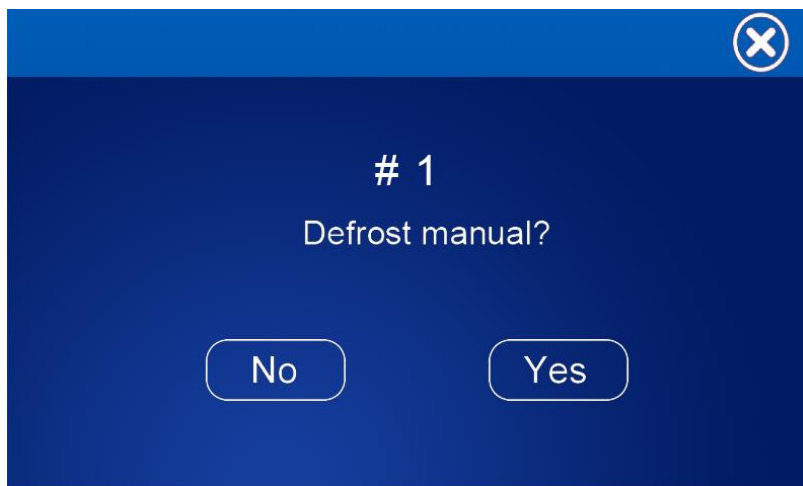

Forced defrosting: In the unit selection interface of the query status, press and hold the corresponding unit number to pop up the forced defrosting selection interface of the corresponding unit. If Yes is selected, the corresponding unit enters forced defrosting.



LIST OF OPERATION PARAMETERS

Code	Description	Remark
01	Water inlet temp.	-30~99°C
02	Water outlet temp.	-30~99°C
03	Ambient temp.	-30~99°C
04	Exhaust gas temp.	0~125°C
05	Return gas temp.	-30~99°C
06	Evaporator coil temp.	-30~99°C
07	Inlet temp. of economizer	-30~99°C
08	Outlet temp. of economizer	-30~99°C
09	Cooling coil temp.	-30~99°C
10	Water tank temp.	-30~99°C
11	Opening of main expansion valve	
12	Opening of assistant expansion valve	
13	Compressor current	
14	Heat sink temp.	
15	Compress target frequency	
16	Compress actual frequency	
17	Low pressure gauge pressure value (R290)	Real time data (Bar)
18	Low pressure conversion temp.	
19	Wind speed of DC fan 1	
20	Wind speed of DC fan 2	
21	EUV powered signal	
22	SG grid signals	
24	DC bus voltage value	
25	Heating Capacity	
26	Current water flow Volume	
27	Current of the entire machine	
28	Voltage	
29	Power Rate	
30	COP(EER)	
31	Target rotation speed of DC water pump	
32	DC pump speed	

CHECK THE ENERGY CONSUMPTION CURVE

Press the "SETTING" key in the main interface to enter the setting interface. Then click "Run the curve" to enter the energy consumption curve interface, click  and  at the bottom of the interface to switch "temperature curve", "operating power curve" and "COP curve"., "heating capacity", "daily power consumption curve", "monthly power consumption curve", "annual power consumption curve".

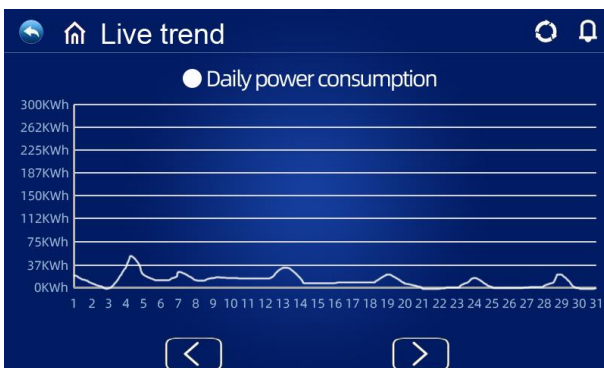
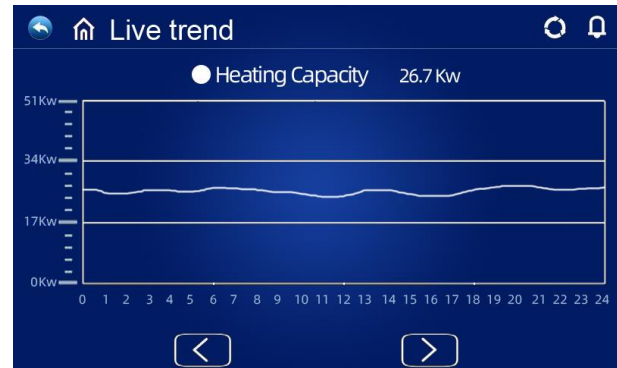
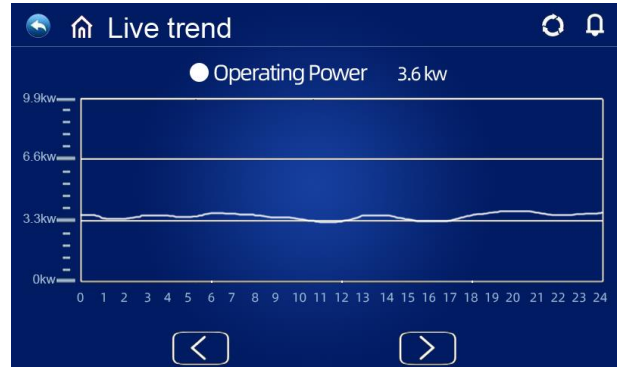
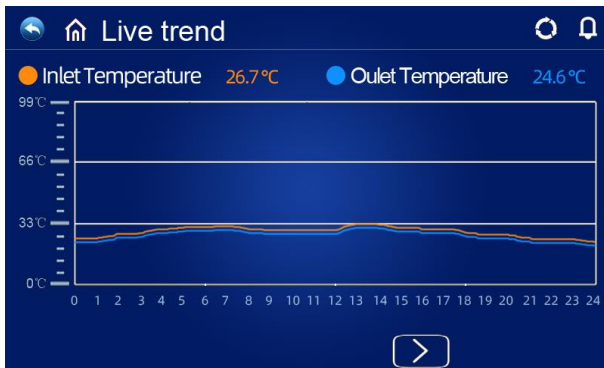

USER PARAMETERS QUERY & SETTING

© Press “SETTING” in the main interface to enter setting interface, then press “USER PARAMETERS” to enter parameter query and setting. Below lists shows the code, definition, range and default value.

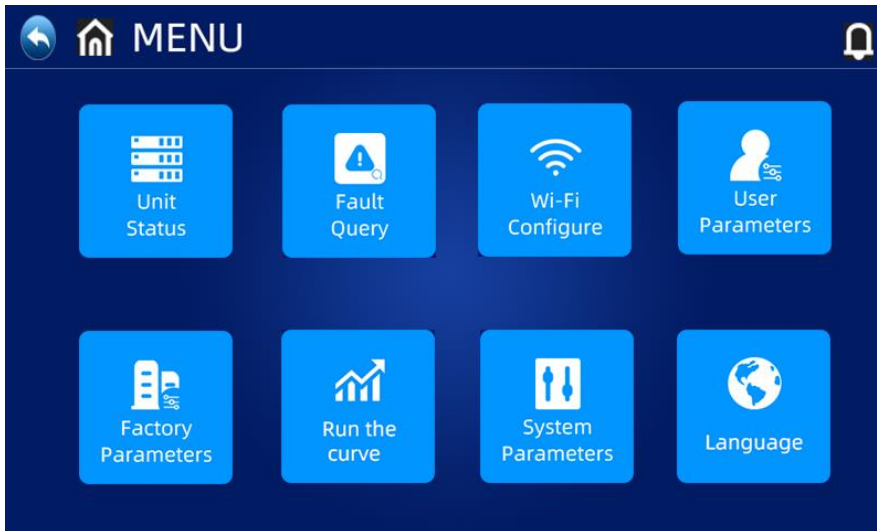

LIST OF USER PARAMETERS

Code	Definition	Settable Range	Default
P01	Temp difference of return water and cooling target temp	2°C~18°C	2°C
P02	Temp difference of return water and hot water target temp	2°C~18°C	5°C
P03	Hot water setting temp.	28°C~70°C	50°C
P04	Cooling setting temp.	7°C~30°C	12°C
P05	Heating setting temp.	15°C~70°C	35°C
P06	Setting temp of exhaust gas too high protection (TP4)	50°C~125°C	120°C
P07	Setting temp of exhaust gas too high recover (tp0)	50°C~125°C	93°C
P08	Water temp. compensation	-5°C~15°C	(inlet/outlet water & water tank)
P09	Defrosting frequency	30-120HZ	70HZ
P10	Defrosting period	20MIN~90MIN	45MIN
P11	Defrosting enter temp.	-15°C~-1°C	-3°C
P12	Defrosting time	5MIN~20MIN	8MIN
P13	Defrost exit temp.	1°C~40°C	15°C
P14	Defrosting environment and evaporator coil temp. difference 1	0°C~15°C	5°C
P15	Defrosting environment and evaporator coil temp. difference 2	0°C~15°C	5°C
P16	Ambient temp. for defrosting	0°C~20°C	17°C
P17	High temperature disinfection cycle days	0~30 days Disinfection function is not executed when set to 0	0
P18	High temperature disinfection start time	0~23:00	23
P19	High temperature disinfection sustaining time	0~90min	30
P20	High temperature disinfection setting temperature	0~90°C	70°C
P21	Heat pump's setting temperature for high temperature disinfection	40~70°C	65°C

	Celsius/Fahrenheit switch	0 Celsius/ 1 Fahrenheit	0
P22	Heating target temperature automatic adjustment enable	0~1 (0 is not enabled, 1 is enabled) (only applicable at heating mode)	0
P23	Heating compensation temperature point (ambient temperature)	0-40	23
P24	Target temperature compensation coefficient	1~30 (1 corresponds to actual 0.1)	6
P25	Compressor's Frequency operation mode after constant Temperature	0-Decrease Frequency after constant Temp. /1-Non Decrease Frequency after constant Temp.	0
P26	Ambient temperature for starting electric heating	-20-20°C	0
P27	Start time for electric heating of water tank	0-60 min	30
F01	Heat Pump Function	1 Heating only 2 Heating+Cooling 3 Heating+DHW 4 Heating+Cooling+DHW	4
F02	Circulation pump status after reaching target temp.	0 Intermittent 1 All time 2 Stop at constant Temp.	1
F03	Circulation pump on-off cycle after reaching set temp.	1-120min	30 (OFF30min ON3min)
F04	DC circulation pump mode	0 No Start 1 Auto 2 Manual	1
F05	DC circulation pump adjustment cycle	10~100S	60
F06	DC water pump manual speed	10~100%	50
F08	Minimum speed of DC circulation pump	10~100%	60
P28	On-line units	1~8	1
P29	Control address	1~255	1
S1	Smart grid capabilities	No, Yes	No
S2	SG operating time	0-600 min	180min

RESTORE FACTORY SETTINGS

In the upper right corner of the factory parameter R interface, there is a parameter reset factory value button. Press this button to pop up the reset parameter confirmation selection. If Yes is selected, the factory default value will be restored:



HIGH TEMPERATURE ANTISEPSIS FUNCTION: (WHEN HOT WATER FUNCTION IS SELECTED)

- ◎ High temperature Antisepsis cycle is once every 7 (P17) days;
- ◎ When entering the high temperature Antisepsis, the water tank electric heater will be forced to turn on.
- ◎ During the Antisepsis process, if the water tank temperature > 65°C(the maximum settable temperature), then the compressor will not start, but only start electric heating; If the water tank temperature ≤60°C, both the compressor and electric heater will start.
- ◎ When the water tank temperature ≥70°C (P20) and the protection temperature lasts for 30 minutes (P19), exit the high temperature Antisepsis;
- ◎ After entering high temperature Antisepsis, if the temperature of the hot water tank does not reach 70°C after 1 hour, the high temperature Antisepsis program will be forced to exit.

TARGET TEMPERATURE AUTO ADJUSTMENT LOGIC (UNDER HEATING MODE)

The target temperature

Under heating mode can be automatically adjusted according to the ambient temperature.

Entry conditions

When Parameter P22=1 enables automatic adjustment mode of heating target temperature.

Calculation formula of heating target temperature

$Pset$ (heating target temperature) = 20 + (P24/10) * (P23 - current ambient temperature)

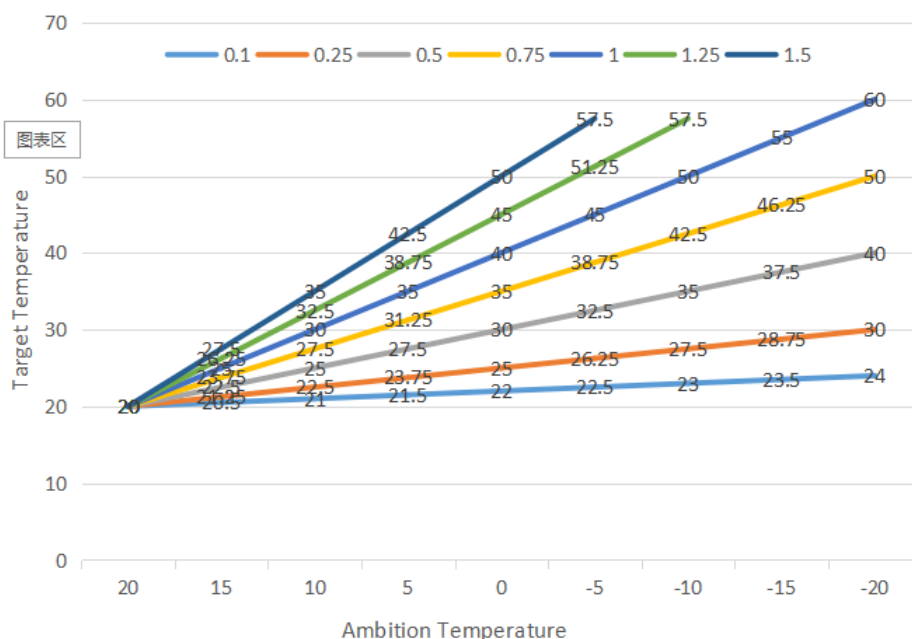

◎ The above different curves stands for the different value of P24.

(When P24=1, the actual value is 0.1)

◎ The target temperature range of automatic temperature adjustment is 20-70°C

AUXILIARY ELECTRIC HEATER FOR WATER TANK

◎ **Start conditions (all below conditions must be met at the same time)**

- 1) In hot water mode;
- 2) The compressor runs for P27 (30) minutes;
- 3) There is a demand for hot water, and the temperature of the water tank is $\leq 70^{\circ}\text{C}$;
- 4) The pump is running.

◎ **Exit condition (only need to meet any one of the below conditions)**

- 1) When the heat pump is performing cooling mode / hot water mode;
- 2) When there is no demand for hot water or constant temperature control;
- 3) The water tank temperature sensor has a fault alarm.

◎ **When it is under defrosting / forced defrosting / secondary anti-freeze , the electric heating is forced to turn on;**

◎ **When there is high-pressure failure / low-pressure failure / exhaust temperature sense failure / excessive exhaust protection stop, and if compressor is locked and cannot be started, then the electric heating will be started instead of the compressor after 5 minutes.**

AUXILIARY ELECTRIC HEATER FOR SPACE HEATING

◎ **Enable condition:**

Under Heating mode;

Ambient Temp. $< P26$ (0°C) Or Ambient Temp. Sensor Fault

There has Heating Demand, Inlet Water Temp. \leq Heating Set Temp. (P05) - Restart difference(P01);

Water pump during Working States

When the above conditions are met, The Electric Heater will turn on.

◎ **Shut-down condition:**

Under Cooling or Hot Water Mode

Without Heating Demand or Constant Temp. Control

Inlet Water Temp. Sensor Failure or Alarm

Ambient Temp. $> 0^{\circ}\text{C}$ (P26) +1

Water Flow Failures

Circulation pump shut-down

E-heater be shut-down when any of above conditions met

SMART GRID

© When the smart grid function parameter is selected to be enabled (S01 = 1), the heat pump starts running the smart grid function

SMART GRID		
Operating State	SG	EVU
Increased operation	ON	ON
	OFF	ON
Normal operation	ON	OFF
Decreased operation	OFF	OFF

- 1) When SG signal is on, and EVU signal is on, when the hot water mode is set to be valid, heat pump will operate hot water mode priority and the hot water mode setting temperature will be change to 70°C. (Water tank temp.) < 69, the TBH is on, (Water tank temp.) ≥ 70, the TBH is off.
- 2) When SG signal is off, and EVU signal is on, when the hot water mode is set to be valid and the mode is on, heat pump will operate hot water mode priority. (Water tank temp.) < P03-P02, the TBH is on, (Water tank temp.) ≥ P03+2, the TBH is off.
- 3) When SG signal is on, and EVU signal is off, the unit operates normally.
- 4) When SG signal is off, and EVU signal is off, the unit will not operate hot water mode, and the TBH is invalid, disinfect function is invalid. The max running time for cooling/heating is 'SG operating time', and then unit will be off.

* TBH: Water tank heater

GENERAL OPERATING GUIDE

Initial Start-up Precautions

First boot-strap and Running state checks

1. To ensure the power same as the product nameplate required power.
2. Unit electrical connections: Check if power supply wire track and connection is ok; if ground wire is properly connected; Check if water pump and other chain device is properly connected
3. Water pipe and pipe: water pipe and pipe must be washed two and three times, ensure clean and no any pollution.
4. Check water system: If the water is enough and no any air, ensure no leakage
5. First boot-strap or starting up again after long time stop, ensure power on ahead and heating at least 12 hours for crankcase (local loop temp. is zero). Water pump start up first, last a while, fan start up, compressor start up, unit regular work.
6. Running checks (according to the following data to check if the unit running is normal)
After unit normal running, check the following item:
 - a. Input and output water temp.
 - b. cycle water flow of the side.
 - c. running electric current of compressor and fan.
 - d. High and low pressure value when heating running.



CAUTION — Refrain from using this heat pump if any electrical components have been in contact with water. Immediately call a qualified service technician to inspect the heat pump.



CAUTION — Keep all objects clear above the heat pump. Blocking air flow could damage the unit and may void the warranty.

USERS' GUIDE

1. Rights and Responsibility

1.1 To ensure you have the service in guarantee period, only the professional server and technology staff can install and repair the unit. If you infract this request and cause any loss and damage, our company will not be claimed any responsibility.

1.2 After receiving the unit, check if have damage on shipment and all parts are complete; any damage and lack of parts please notice the dealer in written.

2. User Guide

- 2.1 All safety protection device are set in unit before leaving factory, don't adjust by yourself.
- 2.2 Unit have enough refrigerant and lubricating oil, don't fill or replace them; if need fill owing to leak, please refer to the quantity on nameplate (if refill refrigerant, need re-vacuum).
- 2.3 External water pump must connect with the message of unit, or else easy show various water lack alarm.
- 2.4 Regular clean water system according to maintenance request.
- 2.5 Pay attention to antifreeze when the environment temp. is less than zero in winter.
- 2.6 Safety Precautions
 - A User can't self-install the unit, ensure agent or specialized install company to do, or else maybe cause safety accident and affect the use effect.
 - B When install or use the unit, please check if the power is corresponding with unit power.
 - C The main power switch of unit should install leakage protector; the power cord must meet unit power request and national standard and local Fire & Safety Regulations.
 - D Unit must have ground wire; don't use the unit if no ground wire; forbid connect the ground wire to null line or water pump.
 - E The main power switch of unit should set much higher 1.4 meter (child don't touch it), to prevent child play it and cause danger.
 - F More than 52°C hot water can cause damage, hot and cold water must be mixed then use it.
 - G When unit is soaking, please contact the factory or maintain department, you can use it again after maintain.
 - H Forbid insert any tools into fan fence of unit, fan is dangerous. (child special care)
 - I Don't use the unit if turn off the fan fence.
 - J To avoid electric shock or cause fire, don't store and use fixture, oil paint and petrol etc. combustible gas or liquid around the unit; don't throw the water or other liquid on the unit and don't touch the unit by wet hand.
 - K Don't adjust the switch, valve, controller and internal data except company server or authorized staff.
 - L If safety protection device often start up, please contact factory or local dealer.

CONTROLLER ERROR CODES

If there's error in the heat pumps, the error code and error definition will be displayed in the main interface, and saved the record in FAULTY column inside the SETTING interface.

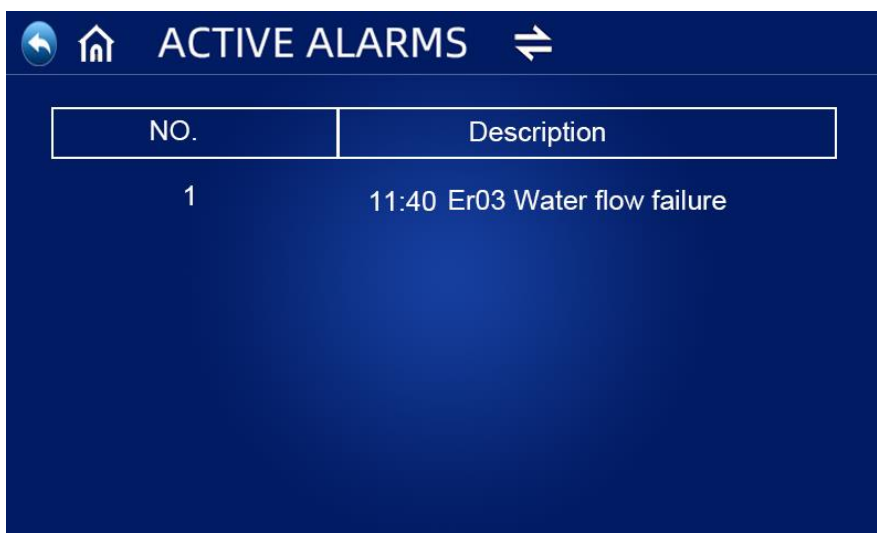

NO.	Description
1	11:40 Er03 Water flow failure

© The following Common Error Codes will be displayed on the controller panel:

Error Code	Definition of Error or Protection
Er 03	Water flow failure
Er 04	Antifreeze in winter
Er 05	High pressure fault
Er 06	Low pressure fault
Er 09	Communication failure
Er 10	Communication failure of frequency conversion module (alarm when communication between outer board and drive board is disconnected)
Er 12	Exhaust temp too high protection
Er 14	Water tank temp. sensor fault
Er 15	Water inlet temp. sensor fault
Er 16	Evaporator coil temp. sensor fault
Er 18	Exhaust temp. fault
Er 20	Abnormal protection of frequency conversion module
Er 21	Ambient temp. sensor fault
Er 23	Cooling outlet water temp. supercooling protection
Er 26	Heat sink temp. fault
Er 27	Outlet water temp. sensor fault
Er 29	Return gas temp. sensor fault
Er 32	Heating too high outlet water temp. protection
Er 33	Coil temp. too high
Er 34	The temp. of frequency conversion module is too high
Er 42	Cooling coil temp. sensor failure
Er 62	Inlet temp. fault of economizer
Er 63	Outlet temp. failure of economizer
Er 64	DC fan 1 fault
Er 66	DC fan 2 fault
Er 67	Low pressure switch failure
Er 68	High pressure switch failure
Er 69	Too low pressure protection
Er 70	Too high pressure protection

When there's Er 20 error in the system, it will display below detailed error code from 1 to 348. Among them, 1~128 are in the first class, when will be displayed as priority, 257~384 are in the second class, which will be displayed only when error 1~128 don't appear. If 2 or more than 2 error occurs simultaneously in the same class, then it will display the sum of the error number. For example, when 16 and 32 exist at the same time, then it will display error code 48 (16+32=48).

DETAILED ERROR CODE LIST FOR ER 20:

Error Code	name	description	Solution suggestion
1	IPM Over-current	IPM Module problem	Replace inverter module
2	compressor synchronous abnormal	Compressor failure	Replace compressor
4	reserved	--	--
8	compressor output phase absent	Compressor wiring disconnected or poor contact	Checking compressor input circuit
16	DC bus low voltage	Input too low voltage, PFC module failure,	Inspect the input voltage, replace module
32	DC bus high voltage	Input voltage too high, PFC Module failure	Replace inverter module
64	Radiator over temperature	Main unit fan motor failure, air duct blockage	Inspect fan motor, air duct
128	Radiator temperature error	Radiator sensor short circuit or open circuit fault	Replace inverter module
257	communication failure	Inverter module doesn't receive order from main controller	Inspect the communication wiring= between main controller and inverter module
258	AC Input phase absent	Input phase absent (Three phase module is effective)	Inspection input circuit
260	AC Input over-current	Input three phase imbalance (three phase module is effective)	Inspection input three phase phase voltage
264	AC Input low voltage	Input low voltage	Inspect input voltage
272	Compressor High pressure failure	Compressor high pressure failure (reserved)	
288	IPM too high temperature	Main unit fan motor failure, air duct blocked	Inspect fan motor and air duct
320	Compressor peak current too high	Compressor line current too high, the driver program doesn't match with compressor	Replace inverter module
384	PFC module over-temperature	PFC Module too high temperature	

Owner Inspection

We recommend that inspections on heat pumps are done frequently, especially after abnormal weather conditions. The following basic guidelines are suggested for your inspection:

1. Make sure the front of the unit is accessible for future service.
2. Keep the top and surrounding areas of the heat pump clear of all debris.
3. Keep all plants and shrubs trimmed and away from the heat pump especially the area above the fan.
4. Keep lawn sprinklers from spraying on the heat pump to prevent corrosion and damage.
5. Ensure that the ground wire is always properly connected.
6. The filter must be maintained on a regular basis in order to ensure clean and healthy water to protect the heat pump from damaging.
7. Keep inspecting power and electrical components' wiring to make sure their normal operation.
8. All the safety protection devices have been set up; please refrain from changing these settings. If any changes are needed, please contact the authorized installer/agent.
9. If the heat pump is installed under roof without a gutter, ensure that all measures are taken to prevent excessive water from flooding the unit.
10. Do not use this heat pump if any electrical part has been in contact with water. Contact an authorized installer/agent.
11. If the increase of power consumption is not due to colder weather, please consult with the local authorized installer/agent.
12. Please turn off the heat pump and disconnect it from the mains power supply, when not in use for a prolonged period of time.

Troubleshooting

Use the following troubleshooting information to resolve issues/problems with your EVI DC Inverter heat pump.

WARNING – RISK OF ELECTRICAL SHOCK OR ELECTROCUTION.



Ensure that all high voltage circuits are disconnected before commencing heat pump installation. Contact with these circuits could result in death or serious injury to users, installers or others, due to electrical shock and may also cause damage to property.

DO NOT open any part of the heat pump as this may result to electrocution.

1. Keep your hands and hair clear of the fan blades to avoid injury.
2. If you are not familiar with your heater:
 - a) **DO NOT** attempt to adjust or service the unit without consulting your authorized installer/agent.
 - b) **PLEASE** read the complete Installation and/or User's Guide before attempting to operate service or adjust the heater.

IMPORTANT: Turn off the mains power supply to the EVI DC Inverter heat pump prior to attempting service or repair.

Maintenance

The EVI DC Inverter air source heat pump unit is highly automation device. If the units are cared and maintained effectively regularly , the operation reliability and the lifetime of the unit will be highly improved.

Important tips below shall be paid more attention to when doing the maintenance:

1. The water filter shall be cleaned termly, to make sure the water is clean, and avoid any damage caused by the filter blockage.
2. All the safety protection device set up already before leaving the factory, forbid to adjust by oneself. We could not take any responsibility for any unit damage caused by the user's self-adjustment.
3. The surrounding of the unit shall be clean, dry and draughty. If the side of the heat exchanger could be cleaned termly(every 1-2 month), the heat exchanging efficiency will be better, and energy saving.
4. The water supplement of water system and air discharge device shall be checked frequently, to avoid the air to enter the system, causing the water circulation decrease, or the water cycle trouble, or it will effect the unit's cooling, heating efficiency and the working reliability .
6. 5. The power of the unit and the electrical wiring shall be checked frequently, make sure the wiring is fastened and the electrical component is normal. If abnormal, it shall be repaired or replaced, the unit shall be connected to the ground reliably.
7. Check every components during the unit operation frequently. Check whether the working pressure of cooling system is normal or not. Check the pipe splice and the air injection valve whether have greasy dirt. Make sure not any refrigerant leakage in the cooling system.
7. Don't stack any sundries around the unit, in case blocking the air inlet and outlet. The surrounding of the unit shall keep clean, dry and draughty.
8. The water in the water system shall be discharged if the unit need to take a long break after running for a period. And the power shall be off, put a cover on the unit. Only after the water system is replenished full with water and the unit is checked roundly, and the unit is power on to warm up for at lease 6 hours, all is fine, then the unit could be started up again.

Notice:

The unit should be equipped with the dedicated power supply. The voltage range should be within $\pm 10\%$. The switch should be automatic air switch. The setting electric current should be 1.5 times of the running current, and equipped with lack of phase safeguard. The knife switch is forbidden to use in the unit.

The unit must be power on to warm up for at lease 12 hours before running every season. If the cooling only models haven't been working for long term in winter, make sure to discharge out all the water, in case the pipe and the unit are damaged by frost. The master controller and the unit should be in correspondence and couldn't be power off if the heating only models stop working for long term in winter, to avoid the frost damage.

The heat pump switch couldn't be operated frequently, can not be over 4 times within one hour. The electric cabinet shall prevent to be affected with damp.

Forbid to flush the EVI DC inverter air source heat pump with water, avoid any electric shock or other accidents.

Common Faults and Debugging

©The user must hire the professional maintenance staff to fix if the unit has any problems during working. The maintenance staff might refer to the chart to debug.

Error Status	Possible reason	Solution
Heat pump not running	Power fault Wiring loose Fuse blow fused Thermal Overloaded protector off Low pressure too low	Put off the power switch, check the power supply find out the causes and repair Replace the fuse blow test the voltage and current
Water pump is working but without water cycle or water pump high noise	Lack of water in the system with air in the water system the valves are not all open filter is dirty and blocked	Check the system replenishment device and replenish the system discharge the air in the water system Open the water system valve Clean the water filter
Low heating capacity	Lack of refrigerant Bad heat preservation of water system; Dry filter blocked Bad heat dissipation of air heat exchanger Not enough water flow	Leakage detecting and supply refrigerant Reinforce the heat preservation of water system Change the dry filter Clean the air heat exchanger Clean the water filter
Compressor not working	Power failure; Contactor of compressor damage; wiring loose Compressor overheat protection outlet water temp. Too high; Not enough water flow Compressor overload protector tripped	Find out the causes and solve the power failure Change the contactor of compressor Find out the loose point and repair Check the unit pressure and Exhaust gas temp. Reset the outlet water temp Clean the water filter and discharge the air in the system Check the running current and whether overload protector damage
compressor running noise too high	Liquid refrigerant enter the compressor The inner parts of compressor damage Too Low voltage	Check the expansion valve whether out of effect Replace the compressor Check Power Voltage
Fan not working	The fastening screw of the fan loose Fan motor damage Contactor damage	Reinforce the screw Replace the fan motor Replace the contactor
Compressor running but heat pump not heating	Refrigerant is all leaking out Compressor fault Compressor reversal	Check leakage and charging the refrigerant Replace the compressor Exchange the phase order of compressor
Low water flow protection	Not enough water flow in the system Water switch fault	Clean the water filter and discharge the air in the system Check the water switch and replace it

APP Download

©Please go to “Google Play Store” or “Apple App Store” and search “Smart Life” or “Tuya Smart” then download. See below figures.

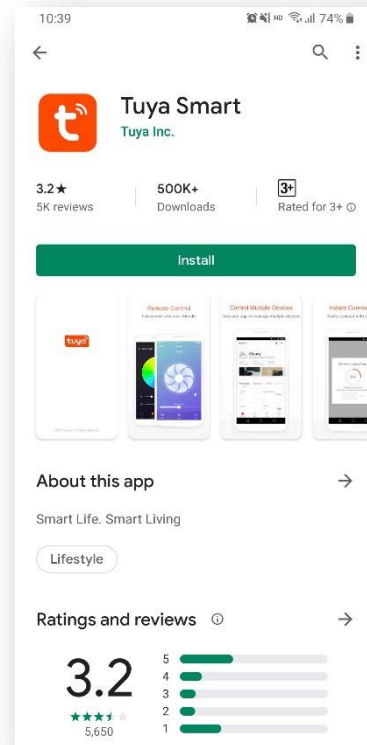
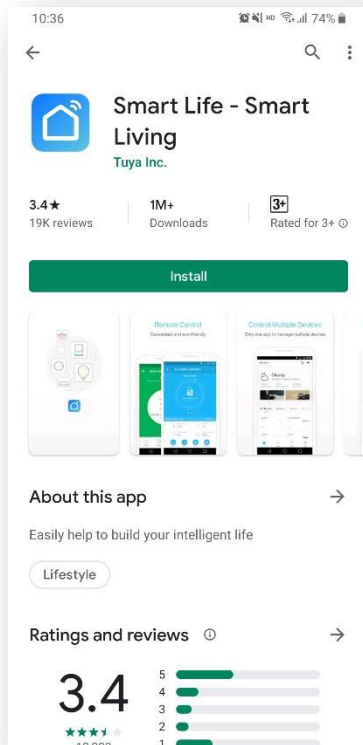

WIFI Connect Method 1: bluetooth mode:

The 1st step:

- ©By default, it can be connected within 10s after the first power-on, and it needs to be connected by pressing buttons after 10 seconds. (10s is the delay for WIFI to enter low power consumption)
- ©Manually enter the smart distribution mode: select "SMART MODE" or "AP MODE" on the WIFI interface of the wired controller, click "WIFI RESET" to enter the smart distribution mode, the "📶" icon on the main interface flashes, and the mobile phone can start to configure the network.

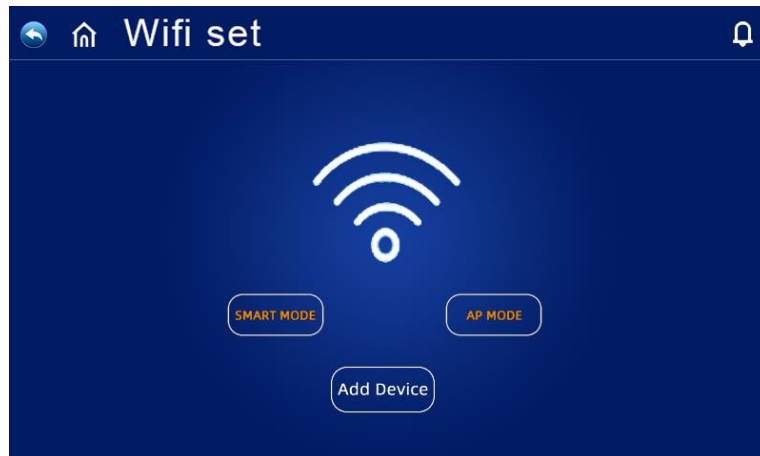

©Exit the network configuration status after 3 minutes, the "  " icon stops flashing, and the WIFI module is no longer networked. If you want to configure the network again, you need to click the "WIFI RESET" button on the WIFI interface again.

The 2nd step:

- ©Turn on the phone's bluetooth
- ©Turn on the WIFI function of the mobile phone and connect to the WIFI hotspot. The WIFI hotspot must be able to connect to the Internet normally, as shown in the figure: Connect the WIFI hotspot "123456789".



The 3rd step:

© Open the "Smart Life" APP, login and enter the main interface, click "+" in the upper right corner or "Add Device" on the interface, The Interface shows Findings "Discovering devices"...Click "Add" To Entering "Add Device" Interface, click "+", Then Select WIFI in the Network selection interface, Input & Confirm the Correct WIFI Password, Click "Next" to Start Matching WIFI.

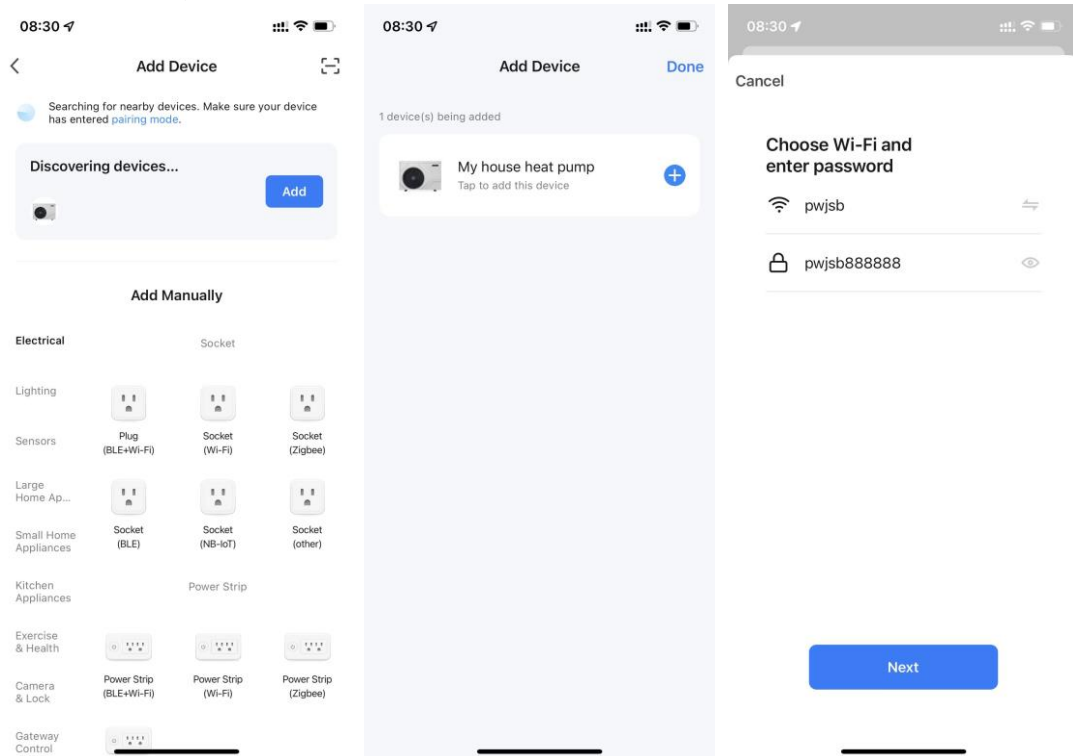

The 4th step:

© When the connection is successful and the system prompts "Added successfully", then the network configuration is successful. Click "Done" to entry Homepage

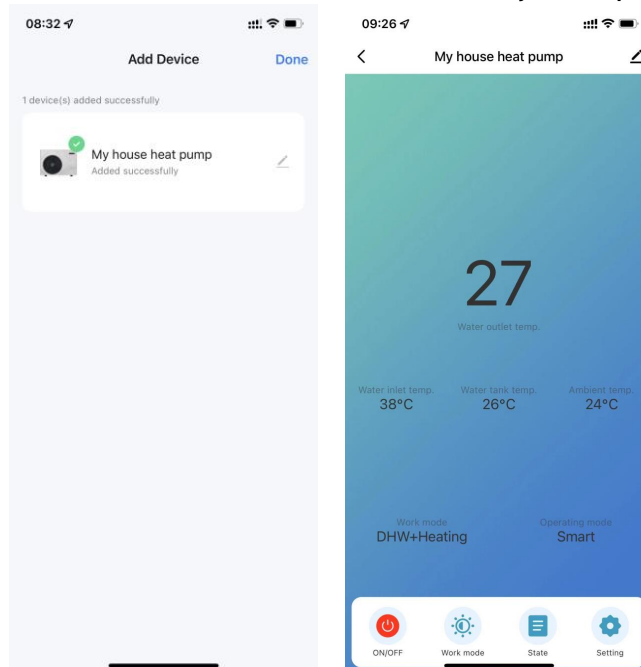

Software function operation

Interface Introduction

- ©After the device is successfully bound, enter the "My house Heat Pump " (device name can be modified) operation page.
- ©Click "My house Heat Pump" in "All Devices" in the main interface of "Smart Life" APP to enter the "My house Heat Pump" device's operation page.

09:26

return < My house heat pump >

Fault information: display fault information when a fault occurs.

More: You can change the device name, select the device installation location, check the network status, add shared users, create a device group, view device information, etc.

27
Water outlet temp.

Water inlet temp. 38°C Water tank temp. 26°C Ambient temp. 24°C

Work mode DHW+Heating Operating mode Smart

Current < > Operating mode

Power button: click to turn on/off

Setting: Click to add timing on/off

Mode switching: Click to select the mode to be switched

Param Query: View unit status data

Mode setting

- © Click "Work mode" on the main interface of the equipment operation to switch mode, and the mode selection interface will pop up as shown in the figure below, just click the mode you need to select.

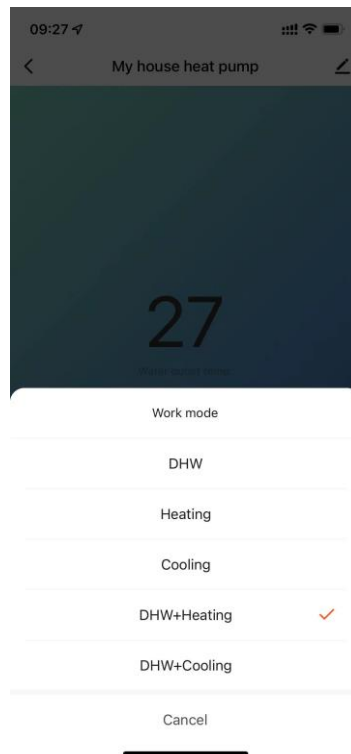

Water Temp. Setting

- © In the Setting interface, click "Water Temp. Setting" to set the Desired Temp. And Return difference Temperature

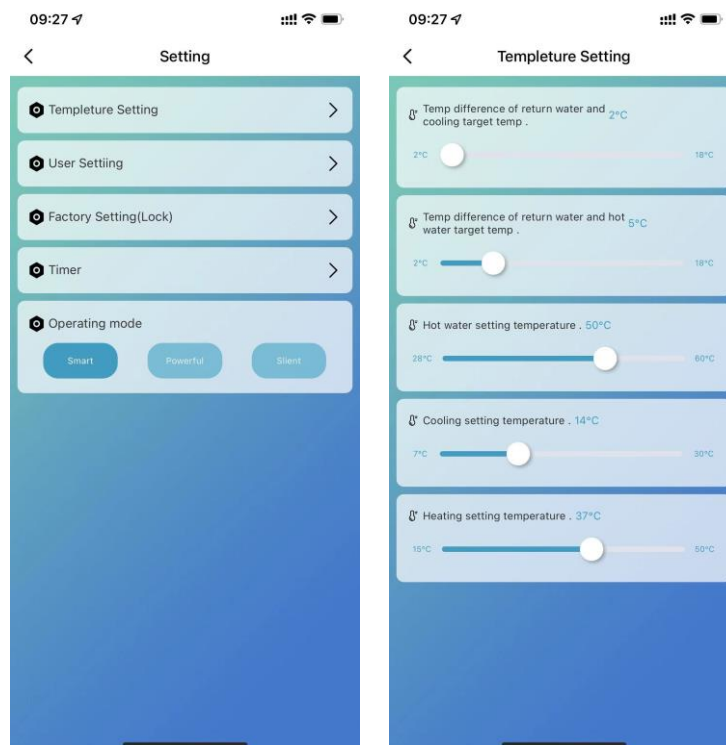

User setting

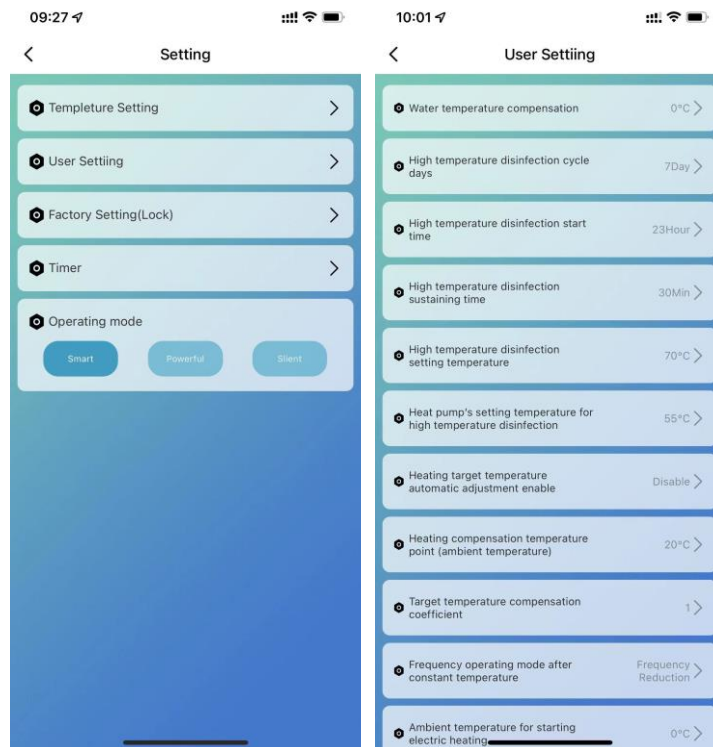

High Temperature Antisepsis Function: (when hot water function is selected)

- ◎ High temperature Antisepsis cycle is once every 7 days (Cancel this function when the selection is 0) ;
- ◎ When entering the high temperature Antisepsis, the water tank electric heater will be forced to turn on.
- ◎ During the Antisepsis process, if the water tank temperature > 60°C (the maximum settable temperature), then the compressor will not start, but only start electric heating; if the water tank temperature ≤55°C, both the compressor and electric heater will start.
- ◎ When the water tank temperature ≥70°C and the protection temperature lasts for 30minutes ≥65°C, exit the high temperature Antisepsis;
- ◎ After entering high temperature Antisepsis, if the temperature of the hot water tank does not reach 65°C after 1 hour, the high temperature Antisepsis program will be forced to exit;

Target Temperature Auto Adjustment Logic (Under Heating Mode)

- ◎ The target temperature under heating mode can be automatically adjusted according to the ambient temperature.
- ◎ Entry conditions
When Parameter enables automatic adjustment mode of heating target temperature.

◎ Calculation formula of heating target temperature

$$P_{set} (\text{heating target temperature}) = 20^{\circ}\text{C} + (\text{Target temperature compensation coefficient} \times 10) \\ * (\text{Heating compensation temperature point} - \text{current ambient temperature})$$

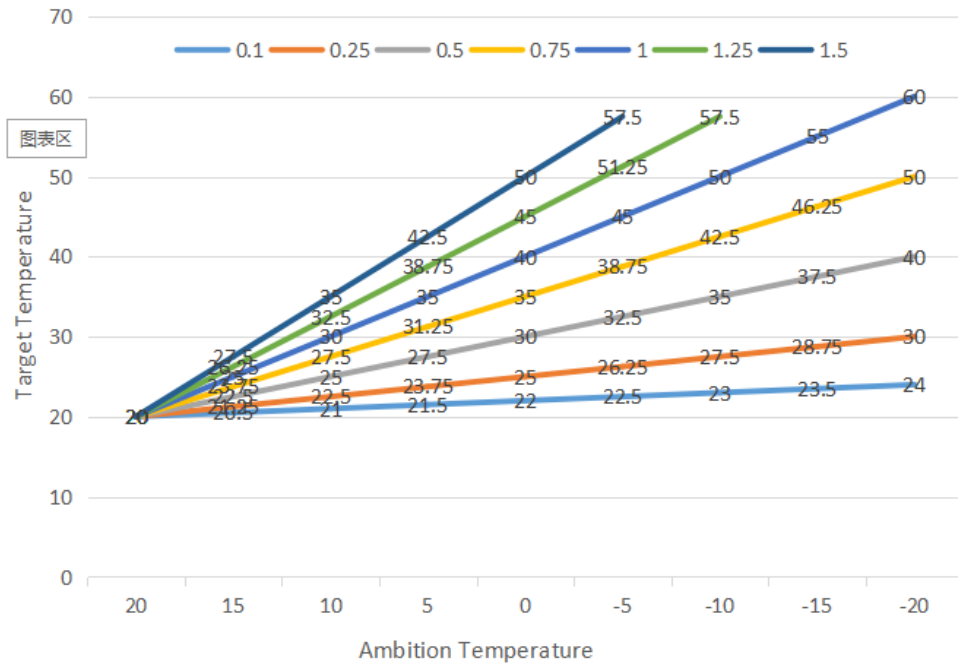

◎ The above different curves stands for the different value of Target temperature compensation coefficient.

(When Target temperature compensation coefficient=1, the actual value is 0.1)

◎ The target temperature range of automatic temperature adjustment is 20-70°C

Auxiliary Electric Heater for Water Tank

◎ Start conditions (all below conditions must be met at the same time)

- 1) In hot water mode;
- 2) The compressor runs for start time for electric heating of water tank (30) minutes;
- 3) There is a demand for hot water, and the temperature of the water tank is $\leq 55^{\circ}\text{C}$;
- 4) The pump is running

◎ Exit condition (only need to meet any one of the below conditions)

- 1) When the heat pump is performing cooling mode / hot water mode;
- 2) When there is no demand for hot water or constant temperature control;
- 3) The water tank temperature sensor has a fault alarm;

◎ When it is under defrosting / forced defrosting / secondary antifreeze , the electric heating is forced to turn on;

◎ When there is high-pressure failure / low-pressure failure / exhaust temperature sense failure / excessive exhaust protection stop, and if compressor is locked and cannot be started, then the electric heating will be started instead of the compressor after 5 minutes.

Auxiliary Electric Heater for Space heating

◎Enable condition:

- 1) Under Heating mode;
- 2) Ambient Temp.<Ambient Temp for starting electric heating (0°C) Or Ambient Temp. Sensor Fault
- 3) There has Heating Demand, Inlet Water Temp.≤Heating Set Temp. (P05) - Restart difference(P01);
- 4) Water pump during Working States

When the above conditions are met, The Electric Heater will turn on.

◎Shut-down condition:

- 1) Under Cooling or Hot Water Mode
- 2) Without Heating Demand or Constant Temp. Control
- 3) Inlet Water Temp. Sensor Failure or Alarm
- 4) Ambient Temp>0°C (Ambient Temp for starting electric heating) +1
- 5) Water Flow Failures
- 6) Circulation pump shut-down

E-heater be shut-down when any of above conditions met

Timer setting

◎In the Setting interface, click "timing" to enter timer setting, click to add timer.

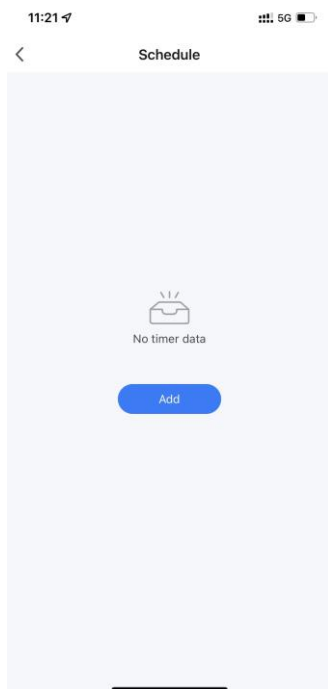

©In the timer setting, slide the hour/minute up and down to set the timer time,and set the repeating week and on/off, press the upper right corner to save, as shown in the below Fig,

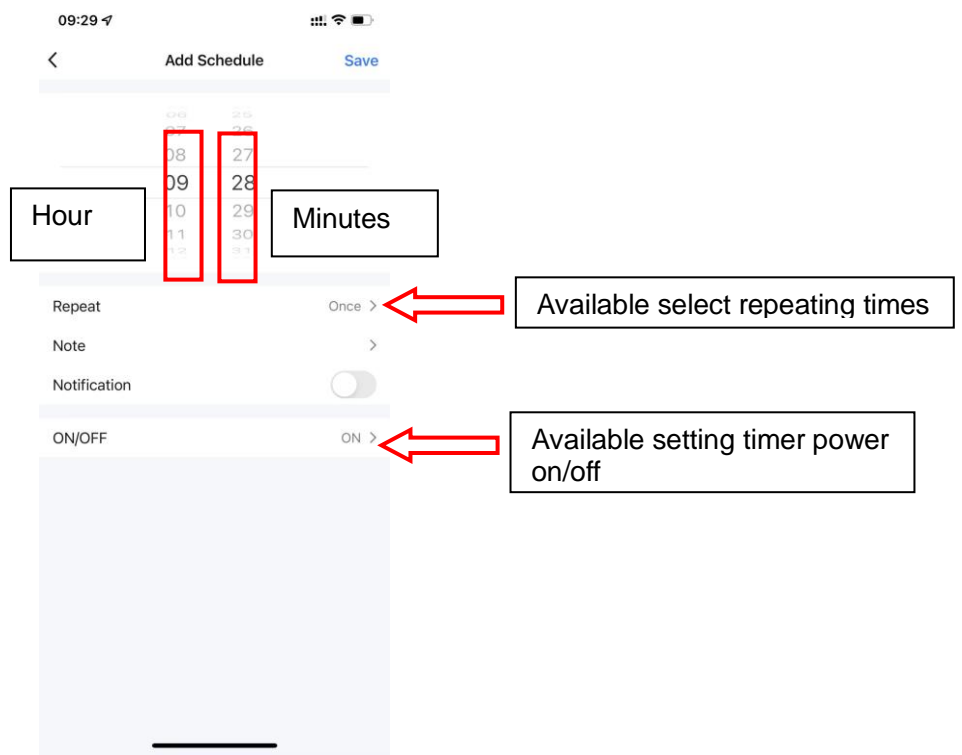

Power consumption curve view

© In the Setting interface, click "Power Statistics Module" to enter the power consumption curve interface.



Equipment sharing

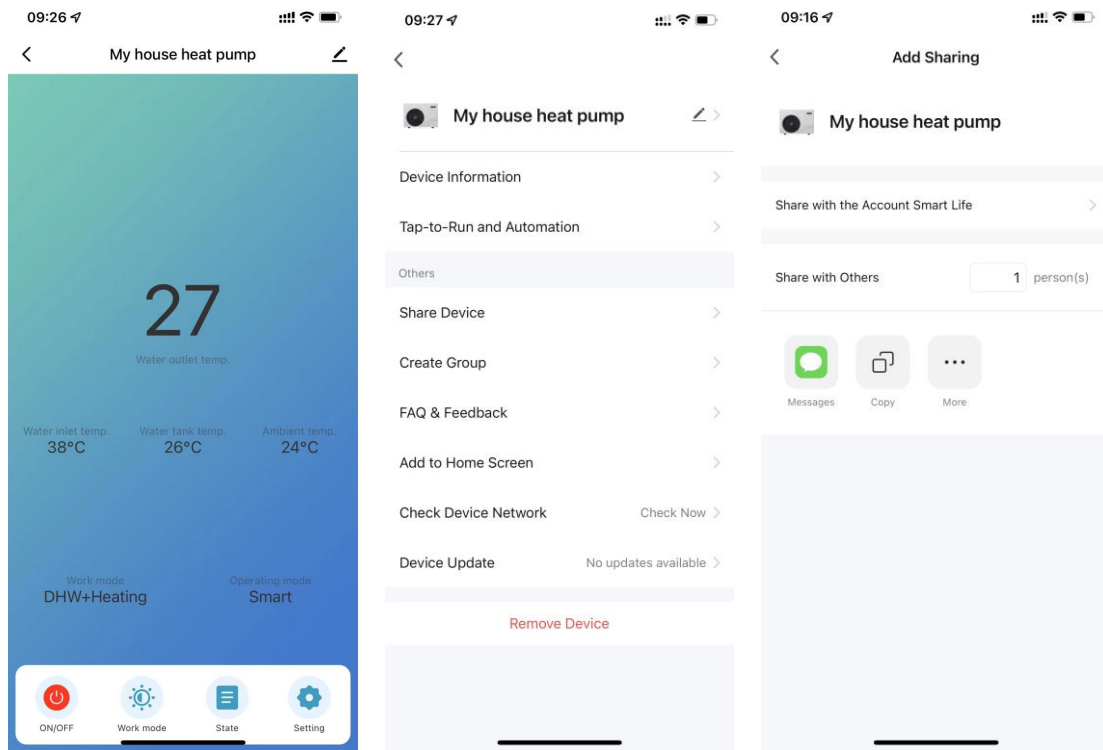

- ◎Share the bound device, the sharer operates in the following sequence.
- ◎After successful sharing, the list will be increased and show the shared person.
- ◎To delete the shared person, long press the selected user, the delete interface will pop up, click "Delete".
- ◎The operation of the sharing interface is as follows:



- ◎Input the account of the shared person, click "Done", the shared success list will display the account of the newly-added shared person. The shared person showing the received shared device, click in to operate and control the device.

Device removal

◎APP removal

Click  in the upper right corner of device operation main interface to enter device details interface, and click "Remove Device" interface to enter the intelligent network configuration mode. " " Corresponding indicator light does not flash, and the network can be reconfigured within 3 minutes. If it exceeds 3mins, it will exit the distribution network.





ALPS EXCLUSIVE CH
ALPS EXCLUSIVE EUROPE
Kryptonstraat 23,
7463 PB Rijssen
Tel. +31 547 234 473
Fax. +31 547 234 473
www.alps-exclusive.ch
www.alps-exclusive.eu
info@alps-exclusive.ch
europe@alps-exclusive.ch

[Ecological solutions](#)

